

WEST SIDE PARKING LOTS & PLAYGROUNDS SEAL & STRIPE

12219 2ND AVE

VICTORVILLE, CA 92395

BID NO. 24-002

PROJECT MANUAL

BID REQUIREMENTS, BID FORMS, CONTRACT FORMS,
CONTRACT REQUIREMENTS, PLANS & SPECIFICATIONS

VICTOR ELEMENTARY SCHOOL DISTRICT

VICTORVILLE, CALIFORNIA

BID SET

PREPARED BY



Erickson-Hall Construction
An Employee Owned Company

11810 Pierce St, Unit 150 Riverside, CA 92505. T: 951.358.0738

EHCC PROJECT NO. 4403

PROJECT MANUAL

TABLE OF CONTENTS

BID REQUIREMENTS

- Notice Inviting Bids
- Instructions to Bidders

BID FORMS TO BE SUBMITTED WITH BID

- Checklist of Mandatory Bid Forms
- Bid Form
- Designation of Subcontractors Form
- Bid Bond Form
- Non Collusion Affidavit
- Acknowledgement of Bidding Practices Regarding Indemnity Form
- Contractor's Certificate Regarding Worker's Compensation
- Contractor's Certificate Regarding Alcohol and Tobacco Free Campus Policy
- Contractor's Certificate Regarding Drug Free Workplace
- DVBE Participation Statement
- Instructions to Bidders for Statement of Experience and Evidence of Responsibility

AGREEMENT FORMS

- Agreement Form
- Payment Bond
- Performance Bond
- Guarantee Form
- Insurance Documents & Endorsements
- Contractor Certification Regarding Background Checks

CONTRACT REQUIREMENTS

- General Conditions
- Special Conditions
- CM Specifications
- Post Bid Interview
- Project Schedule

SPECIFICATIONS PAGES

PLAN SHEET PAGES

BID REQUIREMENTS



Erickson-Hall Construction
An Employee Owned Company

11810 Pierce St, Unit 150 Riverside, CA 92505. T: 951.358.0738

EHCC PROJECT NO. 4403

NOTICE INVITING BIDS

School District: Victor Elementary School District

Bid Deadline: **2:00 P.M. of the 5th day of March, 2024**

Place of Bid Receipt: District Administration Building
12219 2nd Ave
Victorville, CA 92395

Project Identification Name: **West Side Parking Lots & Playgrounds Seal & Stripe # 24-002**

NOTICE IS HEREBY GIVEN that the above named School District of San Bernardino County, California, acting by and through its Governing Board, hereinafter referred to as, "District", will receive up to but no later than the above stated time, sealed bids for the award of a contract for the above project.

A NON-MANDATORY JOB WALK has been scheduled for this project. This job walk will be held **Thursday, February 15, 2024 at 8:00 A.M. beginning at the District Office address noted above and then to each campus in the bid documents either virtually or in person, schedule is to be determined.**

Bids shall be received in the place identified above and shall be opened and publicly read aloud at the above stated time and place.

Each Bid must conform and be responsive to the contract documents.

Prequalification is not a required element for bidding this project as a prime contractor or subcontractor.

The District has obtained from the Director of Industrial Relations the general prevailing rate of per diem wages in the locality in which this work is to be performed for each craft or type of workman needed to execute the contract. Such rates are on file at the District Office.

The bid documents are available after January 29, 2024 from the Construction Manager, Erickson- Hall Construction Company contact Abdull Najjar at anajjar@ericksonhall.com, plans will also be available thru VESD District webpage – <http://vesd.net> / Departments / Business Services / Facility Planning and the Erickson-Hall webpage – ericksonhall.com / current bids. Bidder wishing to receive hard copies of plans can arrange to get them printed at their own expense. There will be no refunds for plans purchased for bidding. Should you have any questions please contact Abdull Najjar with Erickson Hall Construction Company – anajjar@ericksonhall.com.

No bidder may withdraw any bid for a period of sixty (60) calendar days after the date set for the opening of bids.

Each bidder shall be a licensed contractor pursuant to the California Business and Professions Code, and be licensed to perform the work called for in the Contract Documents. The successful bidder must possess a valid and active **A, B or C12** License at the time of bid and throughout the duration of this Contract. The Contractor's California State License number shall be clearly stated on the bidder's proposal

Subcontractors shall be licensed pursuant to California law for the trades necessary to perform the Work called for in the Contract Documents.

Each bid shall be made out on the form contained in the bid documents. Bid forms shall be sealed in a plain envelope with the name of the bidder and the name of the project marked plainly on the face of the envelope and filed with the said Board of Trustees prior to the **2:00:00 P.M., March 5, 2024**, deadline and will be opened and publicly read aloud shortly thereafter on that day in the office of the said Board of Trustees.

First Publication
Second Publication
Job Walk
Opening of Bids
District Name
County Name
Governing Board
By

January 29, 2024
February 5, 2024
February 15, 2024 @ 8:00 A.M.
March 5, 2024 @ 2:00 P.M.
Victor Elementary District
San Bernardino

INSTRUCTIONS FOR BIDDERS

1. Preparation of Bid Form: The District invites bids on the form attached to be submitted at such time and place as is stated in the Notice Inviting Bids. All blanks in the bid form must be appropriately filled in. All bids shall be submitted in sealed envelopes bearing on the outside the name of the bidder, his address, and the name of the project for which the bid is submitted. It is the sole responsibility of the bidder to see that his bid is received in proper time. Post Office date stamp will not suffice for bid deadline. Any bid received after the scheduled closing time for receipt of bids will be returned to the bidder unopened.
2. Bid Security. Each bid must be accompanied by one of the following forms of bidder's security: (1) cash; (2) a cashier's check made payable to the DISTRICT; (3) a certified check made payable to the DISTRICT; or (4) a bidder's bond executed by a California admitted surety as defined in Code of Civil Procedure Section 995.120, made payable to the DISTRICT, in the form set forth in the contract documents. Such bidder's security must be in an amount not less than ten percent (10%) of the maximum amount of such bidder's bid as a guarantee that the bidder will enter into the proposed contract, if the same is awarded to such bidder, and will provide the required Performance Bond and Payment Bond. In the event that a bidder is awarded the contract and such bidder fails to enter into said contract or provide the necessary documents within **five (5)** calendar days after notification of the award of the contract to bidder, said security will be forfeited.
3. Signature: The bid must be signed in the name of the bidder in permanent ink and must bear the signature in longhand of the person or persons duly authorized to sign the bid on behalf of the bidder. It may not be stamped or otherwise reproduced.

If bidder is a corporation, the legal name of the corporation shall first be set forth, together with two signatures: one from the President and one from the Secretary or Assistant Secretary. Alternatively, the signature of other authorized officers or agents may be affixed, if a certified copy of the resolution of the corporate board of directors authorizing them to do so is on file in the DISTRICT's office. Such documents shall include the title of such signatories below the signature and shall bear the corporate seal.

If bidder is a partnership, the true name of the firm shall first be set forth, together with the names of all persons comprising the partnership or co-partnership. The bid must be signed by all partners comprising the partnership unless proof in the form of a certified copy of a statement of partnership acknowledging the signer to be a general partner is presented to the DISTRICT, in which case the general partner may sign.

Bids submitted as joint venturer must so state and be signed by each joint venturer.

Bids submitted by individuals must be signed by the bidder unless an up to date power- of-attorney is on file in the DISTRICT office, in which case, said person may sign for the individual.

The above rules also apply in the case of the use of a fictitious firm name. In addition, however, where a fictitious name is used, it must be so indicated in the signature.

4. Modifications: Changes in or additions to the bid form, recapitulations of the work bid upon, alternative proposals, or any other modification of the bid form which is not specifically called for in the contract documents may result in the DISTRICT's rejection of the bid as not being responsive to the Invitation to Bid. **No oral or telephonic modification of any bid submitted will be considered.**

5. Erasures, Inconsistent or Illegible Bids: The bid submitted must not contain any erasures, interlineations, or other corrections unless each such correction creates no inconsistency and is suitably authenticated by affixing in the margin immediately opposite the correction the signature or signatures of the person or persons signing the bid. In the event of inconsistency between words and figures in the bid price, words shall control figures. In the event that the DISTRICT determines that any bid is unintelligible, inconsistent, or ambiguous, the DISTRICT may reject such bid as not being responsive to the Invitation to Bid.
6. Requirements at Bid Opening: The following documents are required to be included in the sealed bid at bid opening or the bid must be refused: The Bid Form, Bid Bond, Designation of Subcontractors, and the Non-Collusion Affidavit (in accordance with the provisions of Section 7106 of the Public Contracts Code).
7. Bid Protest Procedure: A bidder may protest a bid award if he/she believes that the award is not in compliance with law, Board policy, or the bid specification. A protest must be filed in writing with the Superintendent or designee within five working days after receipt of notification of the contract award and shall include all documents supporting or justifying the protest. A bidder's failure to file the protest documents in a timely manner shall constitute a waiver of his/her right to protest the award of the contract.
8. Examinations of Site and Contract Documents: Each bidder shall visit the site of the proposed work and fully acquaint himself with the conditions relating to the construction and labor so that he may fully understand the facilities, difficulties, and restrictions attending the execution of the work under the contract. Bidders shall thoroughly examine and be familiar with the drawings and specifications. The failure or omission of any bidder to receive or examine any Contract Document, form, instrument, addendum, or other document or to visit the site and acquaint himself with conditions there existing shall in no way relieve any bidder from any obligation with respect to his bid or to the contract. The submission of a bid shall be taken as prima facie evidence of compliance with this section. Bidders shall not, at any time after submission of the bid, dispute, complain, or assert that there were any misunderstandings with regard to the nature or amount of work to be done.
9. **WITHDRAWAL OF BIDS:** Any bid may be withdrawn, either personally or by written request, at any time prior to the scheduled closing time for receipt of bids. The bid security for bids withdrawn prior to the scheduled closing time for receipt of bids, in accordance with this paragraph, shall be returned upon demand therefore.

No bidder may withdraw any bid for a period of sixty (60) calendar days after the date set for the opening of bids.

10. Agreements and Bonds: The Agreement form which the successful bidder, as CONTRACTOR, will be required to execute, and the form of the bonds which such CONTRACTOR will be required to furnish, are included in the contract documents and should be carefully examined by the bidder. Both Payment bond and Performance Bond, each in an amount of one hundred percent (100%) of the amount of the contract will also be required if the bid is \$25,000.00 or more.
11. Interpretation of Plans and Documents: If any person contemplating submitting a bid for the proposed contract is in doubt as to the true meaning of any part of the drawings, specifications, or other Contract Documents, or finds discrepancies in, or omissions from the drawings and specifications, he may submit to the District a written request for an interpretation or correction thereof. The person submitting the request will be responsible for its prompt delivery. **Any interpretation or correction of the contract documents will be made only by Addendum duly issued and a copy of such addendum will be**

mailed or delivered to each person Information for Bidders receiving a set of contract documents. No person is authorized to make any oral interpretation of any provision in the Contract Documents to any bidder, and no bidder is authorized to rely on any such unauthorized oral interpretation. If discrepancies on drawings, specifications or elsewhere in the Contract Documents are not covered by addenda, bidder shall include in their bid methods of construction and materials for the higher quality and complete assembly. Each request for clarification shall be submitted in writing, via email, to only the following persons:

TO: Erickson-Hall Construction Company, Abdjul Najjar – anajjar@ericksonhall.com.

Each transmitted request shall contain the name of the person and/or firm filing the request, address, telephone, and fax number, Specifications and/or Drawing number. Bidder is responsible for the legibility of hand written requests. Pre-bid clarification request shall be filed a minimum of **four (4)** days prior to bid opening. Requests received less than **four (4)** days before bid opening may not be considered or responded to. A written response to timely pre-bid clarifications requests which materially affects the bidders price will be made by Addendum issued by the District not less than seventy-two (72) hours prior to bid opening.

12. Bidders Interested in More Than One Bid: No person, firm or corporation shall be allowed to make, or file, or be interested in more than one bid for the same work unless alternate bids are specifically called for. A person, firm, or corporation that has submitted to a sub-proposal to a bidder, or that has quoted prices of materials to a bidder, is not thereby disqualified from submitting a sub-proposal or quoting prices to other bidders or making a prime proposal.
13. Award of Contract: The DISTRICT reserves the right to reject any or all bids, or to waive any irregularities or informalities in any bids or in the bidding. The award of the contract, if made by the DISTRICT, will be by action of the governing board and to the lowest responsible and responsive bidder therefore from among those bidders responsive to the call for bids. In the event an award is made to bidder, and such bidder fails or refuses to execute the contract and provide the required documents within five (5) calendar days after notification of the award of the contract to bidder, the DISTRICT may award the contract to the next lowest responsible and responsive bidder or release all bidders. **Each bid must conform and be responsive to the contract documents as defined in the General Conditions.**
14. Prices: All prices must be valid for the duration of contract.
15. Evidence of Responsibility. Upon the request of the DISTRICT, a bidder whose bid is under consideration for the award of the contract shall submit promptly to the DISTRICT satisfactory evidence showing the bidder's financial resources, surety and insurance claims experience, construction experience, completion ability, workload, organization available for the performance of the contract, and other factors pertinent to a project of the scope involved.
16. Listing Subcontractors: Each bidder shall submit with his bid, on the form furnished with the contract documents, a list of the names and locations of the places of business of each subcontractor who will perform work or labor or render service to the bidder in or about the project, or a subcontractor who under subcontract to the bidder, specially fabricates and installs a portion of the work, in an amount in excess of one-half of 1 percent of the bidder's total bid as required by the Subletting and Subcontracting Fair Practices Act (Public Contract Code Section 4100, et. seq.). If alternate bids are called for and the bidder intends to use different or additional subcontractors, a separate list of subcontractors must be submitted for each such alternate.
17. Workers' Compensation: In accordance with the provisions of Labor Code Section 3700, the successful bidder as the CONTRACTOR shall secure payment of compensation to all employees. The

CONTRACTOR shall sign and file with the DISTRICT the following certificate prior to performing the work under this contract: "I am aware of the provisions of Section 3700 of the Labor Code, which requires every employer to be insured against liability for workers' compensation or to undertake self-insurance in accordance with the provisions of that code, and I will comply with such provisions before commencing the performance of the work of this contract." The form of such certificate is included as a part of the contract documents.

18. Anti-Discrimination. It is the policy of the DISTRICT that in connection with all work performed under contracts, there be no discrimination against any prospective or active employee engaged in the work because of race, color, ancestry, national origin, religious creed, sex, age, or marital status. The CONTRACTOR agrees to comply with applicable federal and California laws, including, but not limited to, the California Fair Employment and Housing Act, beginning with Government Code section 12900 and Labor Code section 1735. In addition, the CONTRACTOR agrees to require like compliance by any subcontractors employed on the work by such CONTRACTOR.
19. Hold Harmless. CONTRACTOR shall defend, indemnify and hold harmless DISTRICT, Inspector, the State of California and their officers, employees, agents and independent contractors from all liabilities, claims, actions, liens, judgments, demands, damages, losses, costs or expenses of any kind arising from death, personal injury, property damage or other cause based or asserted upon any act, omission, or breach connected with or arising from the progress of Work or performance of service under this Agreement or the Contract Documents. As part of this indemnity, CONTRACTOR shall protect and defend, at its own expense, DISTRICT, Inspector, the State of California and their officers, employees, agents and independent contractors from any legal action including attorneys fees or other proceeding based upon such act, omission, or breach.

Furthermore, CONTRACTOR agrees to and does hereby defend, indemnify and hold harmless DISTRICT, Inspector, the State of California and their officers, employees, agents and independent contractors from every claim or demand made, and every liability, loss, damage, expense or attorneys fees of any nature whatsoever, which may be incurred by reason of:

- (a) Liability for (1) death or bodily injury to persons; (2) damage or injury to, loss (including theft), or loss of use of, any property; (3) any failure or alleged failure to comply with any provision of law or the Contract Documents; or (4) any other loss, damage or expense, sustained by any person, firm or corporation or in connection with the Work called for in this Agreement or the Contract Documents, except for liability resulting from the sole or active negligence, or the willful misconduct of the DISTRICT.
- (b) Any bodily injury to or death of persons or damage to property caused by any act, omission or breach of CONTRACTOR or any person, firm or corporation employed by CONTRACTOR, either directly or by independent contract, including all damages or injury to, loss (including theft), or loss of use of, any property, sustained by any person, firm or corporation, including the DISTRICT, arising out of or in any way connected with Work covered by this Agreement or the Contract Documents, whether said injury or damage occurs either on or off DISTRICT property, but not for any loss, injury, death or damages caused by the sole or active negligence or willful misconduct of the DISTRICT.
- (c) Any dispute between CONTRACTOR and CONTRACTOR's subcontractors/supplies/sureties, including, but not limited to, any stop notice actions.

CONTRACTOR, at its own expense, cost, and risk, shall defend any and all claims, actions, suits, or other proceedings that may be brought or instituted against the DISTRICT, its officers,

agents or employees, on any such claim or liability, and shall pay or satisfy any judgment that may be rendered against the DISTRICT, its officers, agents or employees in any action, suit or other proceedings as a result thereof.

20. Preference for Materials, One Product Specified: Unless the plans and specifications state that no substitution is permitted, whenever the contract documents indicate any specific article, device, equipment, product, material, fixture, patented process, form, method, construction, or any specific name, make, trade name, or catalog number, with or without the words, “or equal,” such specification shall be read as if the language “or equal” is incorporated.
21. Communication: The CONTRACTOR must provide a Supervisor available on the work site at all times who can understand and communicate with all Victor Elementary School District Supervisors and/or District’s Construction Manager, Erickson-Hall Construction Co.
22. Disqualification of Bidders and Proposals. More than one proposal for the same work from any individual, firm, partnership, corporation, or association under the same or different names will not be accepted; and reasonable grounds for believing that any bidder is interested in more than one proposal for the work will be cause for rejecting all proposals in which such bidder is interested and the bidder will forfeit their bid security to the DISTRICT.
23. Unbalanced or Altered Bids. Proposals in which the prices are obviously unbalanced, and those which are incomplete or show any alteration of form, or contain any additions or conditional or alternate bids that are not called for or otherwise permitted, may be rejected. A proposal on which the signature of the bidder has been omitted may be rejected.
24. Non-collusion Affidavit: Public Contract Code Section 7106 requires bidders to submit an affidavit of non-collusion with their bids. This form is included with the bid package and must be signed and dated by the bidder and each subcontractor under penalty of perjury.
25. Wage Rates, Travel and Subsistence.
 - (a) Pursuant to Labor Code Sections 1770 et. seq., the website, www.dir.ca.gov/dlsr.PWD/SOUTHERN.html is available to obtain the general prevailing rate of per diem wages and the general prevailing rate for holiday work and overtime work in the locality in which this public work is to be performed for each craft, classification, or type of worker needed to execute this contract and copies will be made available to any interested party on request. The CONTRACTOR shall obtain his/her own copies of the above referenced prevailing wage sheets from the Director of the Department of Industrial Relations and post a copy of such wage rates at the site.
 - (b) Holiday and overtime work, when permitted by law, shall be paid for at a rate of at least one and one-half (1 ½) times the above.
 - (c) These per diem rates, including holiday and overtime work, and employer payments for health and welfare, pension, vacation, and similar purposes, are on file at the administrative office of the DISTRICT, located as noted above. It shall be mandatory upon the CONTRACTOR to whom the contract is awarded, and upon any subcontractor under such CONTRACTOR, to pay not less than the said specified rates to all workers employed by them in the execution of the contract.

26. No Telephone or Facsimile Availability. No telephone or facsimile machine will be available to bidders on the DISTRICT premises at any time.
27. ADDENDA AND CHANGE ORDERS: All Addenda and Change Orders shall comply with all requirements of Title 24, Article 1, Chapter 4, 4-338.

28. Obtaining Bidding Documents. Bidding Documents, may be obtained from:

Victor Elementary School District – Website <http://vesd.net> / Departments / Business Services / Facility Planning.

OR

District’s Construction Manager, Erickson Hall Construction Company contact Abdull Najjar at anajjar@ericksonhall.com

Bidder shall utilize a complete set of Bidding Documents in preparing a bid. The failure or omission of bidder to receive any Bidding Document, form, instrument, Addendum, or other document shall not relieve bidder from any obligations with respect to the bid and/or Contract.

29. Disabled Veterans Business Enterprise (DVBE) Requirements:

In accordance with Education Code Section 17076.11 the District has a DVBE participation goal of 3% per year of the overall dollar amount of state funds allocated to the District.

Each Trade Contractor shall certify that a good faith effort was made to include DVBE contractors and suppliers in the Project.

BID FORMS
(TO BE SUBMITTED WITH BID)



Erickson-Hall Construction
An Employee Owned Company

11810 Pierce St, Unit 150 Riverside, CA 92505. T: 951.358.0738

EHCC PROJECT NO. 4403

CHECKLIST OF MANDATORY BID FORMS

(For Contractor's use and reference only. Additional documents may be required so bidders should carefully review all Contract Documents and Bid Documents)

- Bid Form
- Designation of Subcontractors
- Bid Bond (or Bid Guarantee form if Security is other than Bid Bond)
- Non-Collusion Affidavit
- Acknowledgment of Bidding Practices Regarding Indemnity
- Contractor's Certificate Regarding Workers Compensation
- Contractor's Certificate Regarding Alcoholic Beverage and Tobacco-Free Campus Policy

- Contractor's Certificate Regarding Drug-Free Work Place

- DVBE Participation Statement
- Statement of Experience

PRE-BID CLARIFICATION FORM (For Contractor's Use)

PROJECT NAME:	West Side Parking Lots & Playgrounds Seal & Stripe		
PROJECT NUMBER:	24-002		
TO:	Abdull Najjar – anajjar@ericksonhall.com	EMAIL:	_____ & _____

DATE:			
FROM:		EMAIL:	
DOCUMENT/DIVISION NUMBER:		DRAWING NUMBER:	

REQUESTED CLARIFICATION:

RESPONSE TO CLARIFICATION:

Attach additional numbered sheets as necessary; however, only one (1) request shall be contained on each submitted form

BID FORM

FOR

West Side Parking Lots & Playgrounds Seal & Stripe

Bid No. 24-002

FOR

VICTOR ELEMENTARY SCHOOL DISTRICT

CONTRACTOR
NAME:

ADDRESS:

TELEPHONE:

()

FAX:

()

EMAIL

TO: Victor Elementary School District, acting by and through its Governing Board, herein called "District".

1. Pursuant to and in compliance with your Notice Inviting Bids and other documents relating thereto, the undersigned bidder, having familiarized himself with the terms of the Contract, the local conditions affecting the performance of the Contract, the cost of the work at the place where the work is to be done, with the Drawings and Specifications, and other Contract Documents, hereby proposes and agrees to perform within the time stipulated, the Contract, including all of its component parts, and everything required to be performed, including its acceptance by the District, and to provide and furnish any and all labor, materials, tools, expendable equipment, and utility and transportation services necessary to perform the Contract and complete all of the Work in a workmanlike manner required in connection with the construction of:

BID SCHEDULE NO. 24-002

West Side Parking Lots & Playgrounds Seal & Stripe

in the District described above, all in strict conformance with the drawings and other Contract Documents on file at the Facilities Office of said District for amounts set forth herein.

2. BIDDER ACKNOWLEDGES THE FOLLOWING ADDENDUM:

Number	Number	Number	Number	Number	Number	Number	Number
_____	_____	_____	_____	_____	_____	_____	_____

Acknowledge the inclusion of all addenda issued prior to bid in the blanks provided above. Your failure to do so may render your bid non-responsive.

3. TOTAL CASH PURCHASE PRICE IN WORDS & NUMBERS:

Bid West Side Schools Price (in words): _____

_____ DOLLARS

Bid West Side Schools Price : \$ _____

Allowance Amount – _____ \$25,000.00 (as confirmed in Special Conditions)

Total of Base Bid plus Allowance (in words): _____

_____ DOLLARS

Total of Base Bid plus Allowance - \$ _____

4. ALTERNATE BIDS:

No Bid Alternates.

5. **TIME FOR COMPLETION: The Contractor can proceed with West Side Parking Lots & Playgrounds Seal & Stripe work after given the Notice to Proceed. Sealing/Striping shall begin no sooner than June 25, 2024 and complete the work no later than August 13, 2024 (31 Working Days), as discussed in the Special Conditions and as coordinated with the Construction Manager.**

The District may give a notice to proceed within sixty (60) days of the award of the bid by the District. Once the Contractor has received the notice to proceed, the Contractor shall complete the work in the time specified in the Agreement. By submitting this bid, Contractor has thoroughly studied this Project and agrees that the Contract Time for this Project is adequate for the timely and proper completion of the Project. Further, Contractor has included in the analysis of the time required for this Project, Rain Days, Governmental Delays, and the requisite time to complete Punch List.

In the event that the District desires to postpone giving the notice to proceed beyond this sixty (60) day period, it is expressly understood that with reasonable notice to the Contractor, giving the notice to proceed may be postponed by the District. It is further expressly understood by the Contractor, that the Contractor shall not be entitled to any claim of additional compensation as a result of the postponement of giving the notice to proceed.

If the Contractor believes that a postponement will cause a hardship to it, the Contractor may terminate the contract with written notice to the District within ten (10) days after receipt by the Contractor of the District's notice of postponement. Should the Contractor terminate the Contract as a result of a notice of postponement, the District shall have the authority to award the Contract to the next lowest responsible bidder, if applicable.

It is understood that the District reserves the right to reject any or all bids and/or waive any irregularities or informalities in this bid or in the bid process. The Contractor understands that it may not withdraw this bid for a period of sixty (60) days after the date set for the opening of bids.

6. Attached is bid security in the amount of not less than ten percent (10%) of the bid:

Bid bond (10% of the Bid), certified check, or cashier's check (circle one)

7. The required List of Designated Subcontractors is attached hereto.

8. The required Non-Collusion Declaration is attached hereto.

9. The Substitution Request Form, if applicable, is attached hereto.

10. It is understood and agreed that if written notice of the acceptance of this bid is mailed, telegraphed, or delivered to the undersigned after the opening of the bid, and within the time this bid is required to remain open, or at any time thereafter before this bid is withdrawn, the undersigned will execute and deliver to the District a Contract in the form attached hereto in accordance with the bid as accepted, and that he or she will also furnish and deliver to the District the Performance Bond and Payment Bond, all within five (5) calendar days after award of Contract, and that the work under the Contract shall be commenced by the undersigned bidder, if awarded the Contract, by the start date provided in the District's Notice to Proceed, and shall be completed by the Contractor in the time specified in the Contract Documents.

11. The names of all persons interested in the foregoing proposal as principals are as follows:

(IMPORTANT NOTICE: If bidder or other interested person is a corporation, state the legal name of such corporation, as well as the names of the president, secretary, treasurer, and manager thereof; if a co-partnership, state the true names of the firm, as well as the names of all individual co-partners comprising the firm; if bidder or other interested person is an individual, state the first and last names in full.)

12. **PROTEST PROCEDURES.** If there is a bid protest, the grounds shall be submitted as set forth in the Instructions to Bidders.

13. The undersigned bidder shall be licensed and shall provide the following California Contractor's license information:

License Number: _____
License expiration date: _____
Name on License: _____
Class of License: _____
DIR Registration Number: _____

If the bidder is a joint venture, each member of the joint venture must include the above information.

14. Time is of the essence regarding this Contract, therefore, in the event the bidder to whom the Contract is awarded fails or refuses to post the required bonds and return executed copies of the Agreement form within five (5) calendar days from the date of receiving the Notice of Award, the District may declare the bidder's bid deposit or bond forfeited as damages.

15. The bidder declares that he/she has carefully examined the location of the proposed Project, that he/she has examined the Contract Documents, including the Plans, General Conditions, Supplemental Conditions, Addenda, and Specifications, all others documents and requirements that are attached to and/or contained in the Project Manual, all other documents issued to bidders and read the accompanying instructions to bidders, and hereby proposes and agrees, if this proposal is accepted, to furnish all materials and do all work required to complete the said work in accordance with the Contract Documents, in the time and manner therein prescribed for the unit cost and lump sum amounts set forth in this Bid Form.

16. **DEBARMENT.** In addition to seeking remedies for False Claims under Government Code section 12650 et seq. and Penal Code section 72, the District may debar a Contractor pursuant to Article 15 of the General Conditions if the Board, or the Board may designate a hearing officer who, in his or her discretion, finds the Contractor has done any of the following:

- a. Intentionally or with reckless disregard, violated any term of a contract with the District;
- b. Committed an act or omission which reflects on the Contractor's quality, fitness or capacity to perform work for the District;

c. Committed an act or offense which indicates a lack of business integrity or business honesty; or

d. Made or submitted a false claim against the District or any other public entity. (See Government Code section 12650, et seq., and Penal Code section 72)

17. DESIGNATION OF SUBCONTRACTORS. In compliance with the Subletting and Subcontracting Fair Practices Act (California Public Contract Code section 4100 et seq.) and any amendments thereof, each bidder shall list subcontractors on the District's form Subcontractor list. This subcontractor list shall be submitted with the bid and is a required form

I agree to receive service of notices at the e-mail address listed below.

I the below-indicated bidder, declare under penalty of perjury that the information provided and representations made in this bid are true and correct.

Proper Name of Company

Name of Bidder Representative

Street Address

City, State, and Zip

()

Phone Number

()

Fax Number

E-Mail

By: _____ Date: _____
Signature of Bidder Representative

NOTE: If bidder is a corporation, the legal name of the corporation shall be set forth above together with the signature of authorized officers or agents and the document shall bear the corporate seal; if bidder is a partnership, the true name of the firm shall be set forth above, together with the signature of the partner or partners authorized to sign contracts on behalf of the partnership; and if bidder is an individual, his signature shall be placed above.

All signatures must be made in permanent ink.

DESIGNATION OF SUBCONTRACTORS

In compliance with the Subletting and Subcontracting Fair Practices Act (California Public Contract Code Sections 4100 et. seq.) and any amendments thereof, each bidder shall set forth below: (a) the name and location of the place of business of each subcontractor who will perform work or labor or render service to the prime contractor, who will perform work or labor or work or improvement to be performed under this contract, or a subcontractor under subcontract to the prime contractor, specially fabricates and installs a portion of the work or improvements according to detailed drawings contained in the plans and specifications in an amount in excess of one-half of one percent of the prime contractor's total bid; and (b) the portion and description of the work which will be done by each subcontractor under this Act. The prime contractor shall list only one subcontractor for each such portion as is defined by the prime contractor in this bid.

If a prime contractor fails to specify a subcontractor, or if a prime contractor specifies more than one subcontractor for the same portion of work to be performed under the contract in excess of one-half of one percent of the prime contractor's total bid, the CONTRACTOR shall be deemed to have agreed that the CONTRACTOR is fully qualified to perform that portion, and that the CONTRACTOR alone shall perform that portion.

No prime contractor whose bid is accepted shall (a) substitute any subcontractor, (b) permit any subcontractor to be voluntarily assigned or transferred or allow the relevant portion of the work to be performed by anyone other than the original subcontractor listed in the original bid, or (c) sublet or subcontract any portion of the work in excess of one-half of one percent of the prime contractor's total bid where the original bid did not designate a subcontractor, except as authorized in the Subletting and Subcontracting Fair Practices Act.

Subletting or subcontracting of any portion of the work in excess of one-half of one percent of the prime contractor's total bid where no subcontractor was designated in the original bid shall only be permitted in cases of public emergency or necessity, and then only after a finding, reduced to writing as a public record, of the authority awarding this contract setting forth the facts constituting the emergency or necessity.

NOTE: If alternate bids are called for and bidder intends to use different or additional subcontractors on the alternates, a separate list of subcontractors must be provided for each such alternate.

DESIGNATION OF SUBCONTRACTORS FORM

Description & Portion of Work	Name of Subcontractor	Location & Place of Business	License Number

DATED: _____

_____ Proper Name of Bidder

By: _____

(Signature of Bidder)

Address: _____

BID BOND

KNOW ALL MEN BY THESE PRESENTS that we, the undersigned,

_____ (hereafter called "Principal"), and _____

_____ (hereafter called "Surety"), are hereby held and firmly bound

unto the Victor Elementary School District (hereafter called "Owner") in the sum of (\$ _____

_____) for the payment of which, well and truly to be made, we hereby jointly and severally bind ourselves, successors, and assigns.

SIGNED this _____ day of _____, 20 _____.

The condition of the above obligation is such that whereas the Principal has submitted to the Owner a certain Bid, attached hereto and hereby made a part hereof, to enter into a contract in writing for the **West Side Parking Lots & Playgrounds Seal & Stripe**.

NOW, THEREFORE,

- a. If said Bid is rejected, or
- b. If said Bid is accepted and the Principal executes and delivers a contract or the attached Agreement form within five (5) days after acceptance (properly completed in accordance with said Bid), and furnishes bonds for his faithful performance of said Contract and for payment of all persons performing labor or furnishing materials in connection therewith,

Then this obligation shall be void; otherwise, the same shall remain in force and effect.

Surety, for value received, hereby stipulates and agrees that no change, extension of time, alteration, or addition to the terms of the contract, or the call for bids, or the work to be performed thereunder, or the specifications accompanying the same, shall in anyway affect its obligation under this bond, and it does hereby waive notice of any such change, extension of time, alteration, or addition to the terms of said contract, or the call for bids, or the work, or to the specifications.

In the event suit is brought upon this bond by the DISTRICT and judgment is recovered, the Surety shall pay all costs incurred by the DISTRICT in such suit, including without limitation, attorneys' fees to be fixed by the court.

IN WITNESS WHEREOF, Principal and Surety have hereunto set their hands and seals, and such of them as are corporations have caused their corporate seals to be hereto affixed and these presents to be signed by their proper officers, on the day and year first set forth above.

PRINCIPAL: _____

ATTEST: (if individual, two witnesses are required)

By: _____

By: _____

Title: _____

Title: _____

ATTEST: (if corporation)

By: _____

Title: _____

(Corporate Seal)

SURETY: _____

ATTEST: (if individual, two witnesses are required)

By: _____

By: _____

Title: _____
(Corporate Seal)

Title: _____

IMPORTANT:

Surety companies executing bonds must possess a certificate of authority from the California Insurance Commissioner authorizing them to write surety insurance defined in California Insurance Code Section 105, and if the work or project is financed, in whole or in part, with federal, grant, or loan funds, it must also appear on the Treasury Department's most current list (Circular 570 as amended).

THIS IS A REQUIRED FORM.

Any claims under this bond may be addressed to:

(Name and Address of Surety)

(Name and Address of agent or representative for service of process in California if different from above)

(Telephone Number of Surety and agent or representative for service of process in California).

**NONCOLLUSION AFFIDAVIT
(Prime Bidder)**

STATE OF CALIFORNIA

County of _____ being first duly sworn, deposes and says that he/she

Is _____ of _____,
(Title) (Name of Bidder)

the party making the foregoing bid; that the bid is not made in the interest of, or on behalf of, any undisclosed person, partnership, company, association, organization, or corporation; that the bid is genuine and not collusive or sham; that the bidder has not directly or indirectly colluded, conspired, connived, or agreed with any bidder or anyone else to put in a sham bid, or that anyone shall refrain from bidding; that the bidder has not in any manner, directly or indirectly, sought by agreement, communication, or conference with anyone to fix the bid price of the bidder or any other bidder, or to fix any overhead, profit, or cost element of the bid price, or of that of any other bidder, or to secure any advantage against the public body awarding the contract of anyone interested in the proposed contract; that all statements contained in the bid are true; and, further, that the bidder has not, directly or indirectly, submitted his or her price or any breakdown thereof, or the contents thereof, or divulged information of date relative thereto, or paid, and will not pay, any fee to any corporation, partnership, company association, organization, bid depository, or to any member of agent thereof to effectuate a collusive or sham bid.

Company: _____

Name: _____

Title: _____

Signature: _____

Date: _____

ACKNOWLEDGMENT OF BIDDING PRACTICES
REGARDING INDEMNITY

TO: VICTOR ELEMENTARY SCHOOL DISTRICT
12219 2nd Ave
Victorville, California 92395

RE: **West Side Parking Lots & Playgrounds Seal & Stripe #24-002**

Please be advised that with respect to the above-referenced PROJECT the undersigned CONTRACTOR on behalf of itself and all subcontractors hereby waives the benefits and protection of Labor Code Section 3864, which provides:

"If an action as provided in this chapter is prosecuted by the employee, the employer, or both jointly against the third person results in judgment against such third person, the employer shall have no liability to reimburse or hold such third person harmless on such judgment or settlement in the absence of a written agreement to do so executed prior to the injury."

This Agreement has been signed by an authorized representative of the contracting party and shall be binding upon its successors and assignees. The undersigned further agrees to promptly notify the DISTRICT of any changes of ownership of the contracting party or any subcontractor while this Agreement is in force.

Contracting Party

Name of Agent/Title

CONTRACTOR' S CERTIFICATE
REGARDING WORKER'S COMPENSATION

Labor Code Section 3700.

Every employer except the State shall secure the payment of compensation in one or more of the following ways:

- (a) By being insured against Liability to pay compensation in one or more insurers duly authorized to write compensation insurance in this State.
- (b) By securing from the Director of Industrial Relations a certificate of consent to self-insure, which may be given upon furnishing proof satisfactory to the Director of Industrial Relations of ability to self-insure and to pay any compensation that may become due to his employees.
- (c) For any county, city and county, municipal corporation, public district, public agency, or any political Subdivision of the State, including each member of a pooling arrangement under a joint exercise of powers agreement (but not the state itself), by securing from the Director of Industrial Relations, a certificate of consent (to self-insure against workers compensation claims, which certificate may be given upon furnishing proof satisfactory to the Director, of ability) to administer workers compensation claims properly, and to pay workers compensation claims that may become due to its employees. On or before March 31, 1979, a political subdivision of the State which, on December 31, 1978, was uninsured for its liability to pay compensation, shall file a properly completed and executed application for a certificate of consent to self-insure against workers compensation claims. This certificate shall be issued and be subject to the provisions of section 3702.

I am aware of the provisions of Section 3700 of the Labor Code which require every employer to be insured against Liability for worker's compensation or to undertake self-insurance in accordance with the provisions of that code, and I will comply with such provisions before commencing the performance of the work of this contract.

DATE: _____

Contractor

By _____
Signature

(In accordance with Article 5 (commencing at Section 1860), Chapter 1, Part 7, Division 2 of the Labor code, the above certificate must be signed and filed with the awarding body prior to performing any work under this contract.

**CONTRACTOR'S CERTIFICATE REGARDING
ALCOHOLIC BEVERAGE and TOBACCO-FREE CAMPUS POLICY**

The CONTRACTOR agrees that it will abide by and implement the DISTRICT's Alcoholic Beverage and Tobacco-Free Campus Policy, which prohibits the use of alcoholic beverages and tobacco products, at any time, on DISTRICT-owned or leased buildings, on DISTRICT property and in DISTRICT vehicles.

DATE: _____

CONTRACTOR

By: _____
Signature

CONTRACTOR'S CERTIFICATE
REGARDING DRUG-FREE WORKPLACE

This Drug-Free Workplace Certification form is required from all successful bidders pursuant to the requirements mandated by Government Code Section 8350 et ~ the Drug-Free Workplace Act of 1990. The Drug-Free Workplace Act of 1990 requires that every person or organization awarded a contract or grant for the procurement of any property or service from any State agency must certify that it will provide a drug-free workplace by doing certain specified acts. In addition, the Act provides that each contract or grant awarded by a State agency may be subject to suspension of payments or termination of the contract or grant, and the contractor or grantee may be subject to debarment from future contracting, if the contracting agency determines that specified acts have occurred.

Pursuant to Government Code Section 8355, every person or organization awarded a contract or grant from a State agency shall certify that it will provide a drug-free workplace by doing all of the following:

- a) publishing a statement notifying employees that the unlawful manufacture, distribution, dispensation, possession or use of a controlled substance is prohibited in the person's or organization's workplace and specifying actions which will, be taken against employees for violations of the prohibition;
- b) establishing a drug-free awareness program to inform employees about all of the following:
 - 1) the dangers of drug abuse in the workplace;
 - 2) the person's or organization's policy of maintaining a drug-free workplace.
 - 3) the availability of drug counseling, rehabilitation and employee-assistance programs;
 - 4) the penalties that may be imposed upon employees for drug abuse violations;
- c) requiring that each employee engaged in the performance of the contract or grant be given a copy of the statement required by subdivision (a) and that, as a condition of employment on the, contract or grant, the employee agrees to abide by the terms of the statement.

I, the undersigned, agree to fulfill the terms and requirements of Government Code Section 8355 Listed above and will publish a statement notifying employees concerning (a) the prohibition of controlled substance at the workplace, (b) establishing a drug-free awareness program, and (c) requiring that each employee engaged in the performance of the contract be given a copy of the statement required by Section 8355 (a) and requiring that the employee agree to abide by the terms of that statement.

I also understand that if the DISTRICT determines that I have either (a) made a false certification herein, or (b) violated this certification by failing to carry out the requirements of Section 8355, that the contract awarded herein is subject to termination, suspension of payments, or both. I further understand that, should I violate the terms of the Drug-Free Workplace Act of 1990, I may be subject to debarment in accordance with the requirements of Section 8350 at seq. I acknowledge that I am aware of the provisions of Government Code Section 8350 et seq. and hereby certify that I will adhere to the requirements of the Drug-Free Workplace Act of 1990.

DATE: _____

Contractor

By _____
Signature

DISABLED VETERAN BUSINESS ENTERPRISE (DVBE) PARTICIPATION
STATEMENT

Each bidder must complete this form in order to comply with Victor Elementary School District (“District”) policy for participation of disabled veteran business enterprises (School District projects funded in whole or in part by the State of California pursuant to the Leroy F. Greene School Facilities Act of 1998. (Education Code §17070.10, *et seq.*)

Project Name: West Side Parking Lots & Playgrounds Seal & Stripe

Bid No.: 24-002

DSA No.: NA

The undersigned, on behalf of the Contractor named below, certifies that the Contractor has made reasonable efforts to secure participation by DVBE in the Contract to be awarded for the above-referenced Bid No., including participation by DVBE subcontractors and/or material suppliers. **Check only one of the following:**

- The Contractor was unable after reasonable efforts to secure DVBE participation in the Contract for the above-referenced Project/Bid No., however, the Contractor will use DVBE services if the opportunity arises at any time during construction of the Project. Upon completion of the Project, the Contractor will report to the District the total dollar amount of DVBE participation in any Contract awarded to Contractor, and in any change orders, for the above-referenced Project.

- The Contractor has secured DVBE participation in the Contract for the above referenced Project/Bid No., and anticipates that such DVBE participation will equal approximately _____dollars (\$_____), which represents approximately _____percent (___%) of the total Contract for such Project. Upon completion of the Project, Contractor will report to the District the actual total dollar amount of DVBE participation in the Contract awarded to Contractor, and in any change orders, for such Project

Company: _____

Name: _____

Title: _____

Signature: _____

Date: _____

**DISABLED VETERAN BUSINESS ENTERPRISE (DVBE) CONTRACTOR CLOSE-
OUT STATEMENT**

The Contractor shall complete this form, as a condition to Final Payment, for purposes of reporting participation by Disabled Veteran Business Enterprises (DVBE) in the Contract for the Project/Bid No. specified below.

Project Name: West Side Parking Lots & Playgrounds Seal & Stripe

Bid No.: 24-002

DSA No.: NA _____

Name	Address/Phone	Category of Work*	\$ Amount of Contract

* Categories of work include: (1) construction services (specify services that DVBE will provide); (2) architecture and engineering services; (3) procurement of materials, supplies and equipment; and (4) information technology.

The undersigned, on behalf of the Contractor, certifies that DVBE participation on the Contract for Bid No. _____ equaled _____ dollars (\$ _____), which represents approximately _____ percent (____%) of the total Contract price including change orders for the Project.

Company: _____

Name: _____

Title: _____

Signature: _____

Date: _____

INSTRUCTION TO BIDDERS FOR STATEMENT
OF EXPERIENCE AND EVIDENCE OF RESPONSIBILITY

- A. Requirements to qualify for consideration by the Victor Elementary School District as a Bidder under the attached ‘Invitation to Bid’:
1. Contractor and Sub—Contractors; a proper license from the California State Contractors License Board, applicable to the work being bid.
 2. Appropriate Bid Security must be submitted by the contractors through a bond, certified check or cash in an amount of at least 10% of the bid. If not available at the time of the bid, the bid proposal will be considered “NON—RESPONSIVE”.
 3. The Contractor shall have the ability to obtain payment bond and Performance Bond (if the total bid is \$25,000 or more) for the contract amount in the time specified in the Contract Document.
 4. The Contractor must list all sub—contractors over one half of one percent of the prime Contract total bid.
 5. The Contractor must present his bid proposal separate and apart from and not in collusion with any other bidders.
 6. The Contractor must submit a fully completed and signed Contractor’s Statement of Experience.
- B. The Victor Elementary School District has the right to verify all information submitted to it by all Contractors or sub—contractors bidding. The District reserves the right to sole and exclusive judgment in the determination of the qualifications of the bidders.
- C. All bidders will be required to sign a statement, under penalty of perjury, acknowledging that they have:
1. Submitted information that is full, true and complete.
 2. Read and understand the requirements.
- D. Disqualification of Bidders — A number of causes, including but not limited to, any one or more of the following causes may be considered as sufficient for disqualification of a bidder.
1. More than one proposal for the same work from an individual, partnership, or corporation.
 2. Evidence of Collusion among bidders. Participants in such collusion will receive no recognition as bidders for any future work of the District until such participants have been reinstated as a qualified bidder by the District.
 3. The Contractor has, within the last two years, been assessed liquidated damages for any project because of willful violation of the terms of the Contract.
 4. The Contractor has been declared to be in default on any recent Public Works or Private Sector job.
 5. Willfully or knowingly failing, where required, to pay prevailing wages and benefits or other state and/or federal required taxes or contributions.
 6. Current litigation, complaint, or investigation by any public agency or owner relative to prior contracts.

7. Outstanding judgments, demands, or liens resulting from violating the State Labor code, Civil or Criminal Codes.
8. Unsatisfactory performance record as shown by past work for any school district, judged from the standpoint of workmanship and progress.
9. Prior commitments, obligations, litigation, fines or penalties, which in the judgment of the District, might hinder or prevent the prompt completion of the work.
10. An improper contractor's license from the California State License Board, a suspended or revoked contractor's license or bond for that license.
11. Failure to pay or satisfactorily settle, all bills due for labor or materials on former school district construction contracts.
12. Failure to comply with any qualification regulation of the District.
13. Failure to provide the Contractor's Statement of Experience.
14. Failure to provide an affidavit.

Should a bidder be found to be of questionable status, then that bidder shall be notified of the reasons for the determination and the bidder shall be allowed to respond. The questionable bidder's response may be either in writing or oral. Should the bidder ultimately be disqualified for reasons for non—responsibility, the bidder shall be entitled to a hearing in accordance with District rules and laws of the State of California before the Governing Board prior to final disqualification.

STATEMENT OF EXPERIENCE

(If additional space is required for your response, please use the attached continuation page)

1. Name of Firm: _____

2. Address of Firm: _____

_____ Zip Code: _____

Telephone No. () _____

3. State of Organization: _____

4. State License Number _____

Types of Valid California Contracting Licenses Held and Expiration Date:

5. Age of Firm: _____

6. Officers or Principals of Firm: (Include Name, Address, and Phone No)

7. Have Principal(s) ever declared bankruptcy? _____, Had License(s) Suspended? _____,
If so, please explain:

8. Have you ever failed to complete any work awarded to you?_____ If so, note when, where, and why:

9. Has any officer or partner of your organization ever been an officer or partner of another organization that failed to complete Construction Contract?_____ If so, state circumstances:

10. Has the contractor ever been disqualified from bidding on a State of California project, school district project, or other public work?_____ If so, explain:

11. Experience Record of Key Staff: (Include Name, Position, and Years of Experience)

12. Please list all work in excess of \$100,000 your organization has in process on this date:

Name of Project:_____ Contract Amount:_____

Owner/Contact Person:_____ Phone No:()_____

% Completion:_____ Completion Date:_____

Name of Project:_____ Contract Amount:_____

Owner/Contact Person:_____ Phone No.:()_____

% Completion:_____ Completion Date:_____

13. Please list the following information regarding Work and cost of Work Completed Within Past Two Years by Firm:

Name of Project: _____ Contract Cost: _____

Owner/Contact Person: _____ Phone No.:() _____

Bonding Company:: _____

Contract Person: _____ Year Completed: _____

Name of Project: _____ Contract Cost: _____

Owner/Contact Person: _____ Phone No.:() _____

Bonding Company:: _____

Contract Person: _____ Year Completed: _____

14. In the last two years, are there now pending any actions against you or have you had to pay back wages, either because of a settlement or judgment with the California State Department of Labor Standards Enforcement for failure to pay prevailing wages? If none, so state:

Name of Project: _____ Date Filed: _____

Disposition: _____ Explain: _____

15. Please list the Financial Institution where line(s) of credit have been established:

Name: _____ Phone No.: _____

Contact Person: _____

16. Signature of Contractor: _____

CONTRACT FORMS



Erickson-Hall Construction
An Employee Owned Company

11810 Pierce St, Unit 150 Riverside, CA 92505. T: 951.358.0738

EHCC PROJECT NO. 4403

AGREEMENT FORM

THIS AGREEMENT, entered into this ____ day of _____, 2024 in the County of San Bernardino of the State of California, by and between the Victor Elementary School District, hereinafter called the “District”, and _____, hereinafter called the “Contractor”.

WITNESSETH that the District and the Contractor for the consideration stated herein agree as follows:

ARTICLE 1 - SCOPE OF WORK: The Contractor shall furnish all labor, materials, equipment, tools, and utility and transportation services, and perform and complete all work required in connection with West Side Parking Lots & Playgrounds Seal & Stripe (“Project”) in strict accordance with the Contract Documents enumerated in Article 7 below. The Contractor shall be liable to the District for any damages arising as a result of a failure to comply with that obligation, and the Contractor shall not be excused with respect to any failure to so comply by an act or omission of the Architect, Engineer, Inspector, Division of the State Architect (DSA), or representative of any of them, unless such act or omission actually prevents the Contractor from fully complying with the Contract Documents and the Contractor protests, in accordance with the Contract Documents, that the act or omission is preventing the Contractor from fully complying with the Contract Documents. Such protest shall not be effective unless reduced to writing and filed with the District office within seven (7) days of the date of occurrence of such act or omission preventing the Contractor from fully complying with the Contract Documents.

ARTICLE 2 - TIME OF COMPLETION: The District may give notice to proceed within sixty (60) days of the award of the bid by the District. Once the Contractor has received a notice to proceed, the Contractor shall reach Substantial Completion of the Work within Thirty One (31) working days from receipt of the Notice to Proceed. This shall be called Contract Time. It is expressly understood that time is of the essence.

Contractor has thoroughly studied the Project and has satisfied itself that the time period for this Project was adequate for the timely and proper completion of the Project within each milestone and within the Contract time. Further, Contractor has included in the analysis of the time required for this Project, items set forth in General Conditions, and Special Conditions, Submittal Schedules, Rain Day Float, and Governmental Delay Float.

In the event that the District desires to postpone giving the notice to proceed beyond this sixty (60) day period, it is expressly understood that with reasonable notice to the Contractor, giving the notice to proceed may be postponed by the District. It is further expressly understood by the Contractor, that the Contractor shall not be entitled to any claim of additional compensation as a result of the District’s postponement of giving the notice to proceed.

If the Contractor believes that a postponement will cause hardship to it, the Contractor may terminate the Contract with written notice to the District within ten (10) days after receipt by the Contractor of the District’s notice of postponement. It is further understood by the Contractor that in the event that the Contractor terminates the Contract as a result of postponement by the District, the District shall only be obligated to pay the Contractor for the work performed by the Contractor at the time of notification of postponement. Should the Contractor terminate the Contract as a result of a notice of postponement, the District shall have the authority to award the Contract to the next lowest responsible bidder.

ARTICLE 3 - LIQUIDATED DAMAGES: It being impracticable and infeasible to determine the amount of actual damage, it is agreed that the Contractor will pay the District the sum of Five Hundred

Dollars_(\$_500.00_) per calendar day for each and every day of delay beyond the Contract Time set forth in Article 2 of this Agreement (inclusive of Milestones that are critical on the critical path or noted as critical to the District) as liquidated damages and not as a penalty or forfeiture. In the event Liquidated Damages are not paid, the Contractor further agrees that the District may deduct such amount thereof from any money due or that may become due the Contractor under the Contract (See Article 9.6 and 2.2 of the General Conditions). This Article shall not be construed as preventing the District from the recovery of damages (actual or other) under the Contract Documents.

ARTICLE 4 - CONTRACT PRICE: The District shall pay to the Contractor as full consideration for the faithful performance of the Contract, subject to any additions or deductions as provided in the Contract Documents, the sum of _____ DOLLARS (\$_____), said sum being the total amount stipulated in the Bid Contractor submitted. Payment shall be made as set forth in the General Conditions.

Should any Change Order result in an increase in the Contract Price, the cost of such Change Order shall be agreed to in advance by the Contractor and the District, subject to the monetary limitations set forth in Public Contract Code section 20118.4. In the event that the Contractor proceeds with a Change in work without an agreement between the District and Contractor regarding the cost of a Change Order, the Contractor waives any Claim of additional compensation for such additional work.

ARTICLE 5 - HOLD HARMLESS AGREEMENT: Contractor shall defend, indemnify and hold harmless District, Architect, Inspector, the State of California and their officers, employees, agents and independent contractors from all liabilities, claims, actions, liens, judgments, demands, damages, losses, costs or expenses of any kind arising from death, personal injury, property damage or other cause based or asserted upon any act, omission, or breach connected with or arising from the progress of Work or performance of service under this Agreement or the Contract Documents. As part of this indemnity, Contractor shall protect and defend, at its own expense, District, Architect, Construction Manager, Inspector, the State of California and their officers, employees, agents and independent contractors from any legal action including attorney's fees or other proceeding based upon such act, omission, breach or as otherwise required by this Article.

Furthermore, Contractor agrees to and does hereby defend, indemnify and hold harmless District, Architect, Construction Manager, Inspector, the State of California and their officers, employees, agents and independent contractors from every claim or demand made, and every liability, loss, damage, expense or attorney's fees of any nature whatsoever, which may be incurred by reason of:

(a) Liability for (1) death or bodily injury to persons; (2) damage or injury to, loss (including theft), or loss of use of, any property; (3) any failure or alleged failure to comply with any provision of law or the Contract Documents; or (4) any other loss, damage or expense, sustained by any person, firm or corporation or in connection with the Work called for in this Agreement or the Contract Documents, except for liability resulting from the sole or active negligence, or the willful misconduct of the District.

(b) Any bodily injury to or death of persons or damage to property caused by any act, omission or breach of Contractor or any person, firm or corporation employed by Contractor, either directly or by independent contract, including all damages or injury to or death of persons, loss (including theft) or loss of use of any property, sustained by any person, firm or corporation, including the District, arising out of or in any way connected with Work covered by this Agreement or the Contract Documents, whether said injury or damage occurs either on or off District property, but not for any loss, injury, death or damages caused by the sole or active negligence or willful misconduct of the District.

(c) Any dispute between Contractor and Contractor's subcontractors/supplies/ Sureties, including, but not limited to, any failure or alleged failure of the Contractor (or any person hired or employed directly or indirectly by the Contractor) to pay any Subcontractor or Materialman of any tier or any other person employed in connection with the Work and/or filing of any stop notice or mechanic's lien claims.

Contractor, at its own expense, cost, and risk, shall defend any and all claims, actions, suits, or other proceedings that may be brought or instituted against the District, its officers, agents or employees, on account of or founded upon any cause, damage, or injury identified herein Article 5 and shall pay or satisfy any judgment that may be rendered against the District, its officers, agents or employees in any action, suit or other proceedings as a result thereof.

The Contractor's and Subcontractors' obligation to defend, indemnify and hold harmless the Owner, Architect, Inspector, the State of California and their officers, employees, agents and independent contractors hereunder shall include, without limitation, any and all claims, damages, and costs for the following: (1) any damages or injury to or death of any person, and damage or injury to, loss (including theft), or loss of use of, any property; (2) breach of any warranty, express or implied; (3) failure of the Contractor or Subcontractors to comply with any applicable governmental law, rule, regulation, or other requirement; (4) products installed in or used in connection with the Work; and (5) any claims of violation of the Americans with Disabilities Act ("ADA").

ARTICLE 6 - PROVISIONS REQUIRED BY LAW: Each and every provision of law and clause required to be inserted in this Contract shall be deemed to be inserted herein, and this Contract shall be read and enforced as though it were included herein, and if through mistake or otherwise any such provision is not inserted or is not inserted correctly, then upon application of either party the Contract shall forthwith be physically amended to make such insertion or correction.

ARTICLE 7 - COMPONENT PARTS OF THE CONTRACT: The Contract entered into by this Agreement consists of the following Contract Documents, all of which are component parts of the Contract as if herein set out in full or attached hereto:

Notice Inviting Bids
Instructions to Bidders
Designation of Subcontractors
Non-Collusion Declaration
Bid Guarantee Form
Bid Bond
Bid Form
Contractor's Certificate Regarding Worker's Compensation
Acknowledgment of Bidding Practices Regarding Indemnity
DVBE Participation Statement and Close-Out Forms
Agreement Form
Payment Bond
Performance Bond
Guarantee
Workers' Compensation/Employers Liability Endorsement
General Liability Endorsement
Automobile Liability Endorsement
Contractor's Certificate Regarding Drug-Free Workplace
Contractor's Certificate Regarding Alcohol and Tobacco

Contractor's Certificate Regarding Background Checks
General Conditions
Special Conditions
CM Specifications
Specifications
All Addenda as Issued
Drawings/Plans
Requirements, Reports and/or Documents in the Project Manual or Other Documents Issued to Bidders

All of the above named Contract Documents are intended to be complementary. Work required by one of the above named Contract Documents and not by others shall be done as if required by all.

ARTICLE 8 - PREVAILING WAGES: Wage rates for this Project shall be in accordance with the general prevailing rate of holiday and overtime work in the locality in which the work is to be performed for each craft, classification, or type of work needed to execute the Contract as determined by the Director of the Department of Industrial Relations. Copies of schedules of rates so determined by the Director of the Department of Industrial Relations are on file at the administrative office of the District and are also available from the Director of the Department of Industrial Relations.

The following are hereby referenced and made a part of this Agreement and Contractor stipulates to the provisions contained therein.

1. Chapter 1 of Part 7 of Division 2 of the Labor Code (Section 1720 et seq.)
2. California Code of Regulations, Title 8, Chapter 8, Subchapters 3 through 6 (Section 16000 et seq.)

ARTICLE 9 - RECORD AUDIT: In accordance with Government Code section 8546.7 (and Davis Bacon, if applicable) and Article 13.11 of the General Conditions, records of both the District and the Contractor shall be subject to examination and audit for a period of five (5) years after a Final Retention Payment or the Recording of a Notice of Completion, whichever occurs first.

ARTICLE 10 - CONTRACTOR'S LICENSE: The Contractor must possess throughout the Project a Class **A, B or C12** Contractor's License, issued by the State of California, which must be current and in good standing.

[SIGNATURES ON THE FOLLOWING PAGE]

IN WITNESS WHEREOF, this Agreement has been duly executed by the above named parties, on the day and year first above written.

Victor Elementary School District

CONTRACTOR:

By: _____

Typed or Printed Name

By: _____

Title

Dated: _____

Signature

Type or Printed Name

Title (Authorized Officers or Agents)

Signature

(CORPORATE SEAL)

PAYMENT BOND (LABOR AND MATERIALS)

KNOW ALL MEN BY THESE PRESENTS That

WHEREAS, the Victor Elementary School District (hereinafter designated as the "District"), has awarded to _____ hereinafter designated as the "Principal", a contract for the work described as follows: _____ (the "Work"); and

WHEREAS, Principal is required by **Division 4, Part 6, Title 3, Chapter 5, (commencing at Section 9550) of the California Civil Code** to furnish a bond in connection with the contract described above; providing that if Principal or any of its Subcontractors shall fail to pay for any materials, provisions, provender, equipment, or other supplies used in, upon, for or about the performance of the work contracted to be done, or for any work or labor done thereon of any kind, or for amounts due under the **Unemployment Insurance Code Section 13020**, or for any amounts required to be deducted, withheld, and paid over to the Employment Development Department from the wages of employees of Principal and its Subcontractors with respect to such work or labor the Surety on this bond will pay for the same to the extent hereinafter set forth.

NOW THEREFORE, we, the Principal and _____ as Surety, are held and firmly bound unto the District in the penal **sum of _____ Dollars (\$.)** lawful money of the United States of America, for the payment of which sum well and truly to be made, **we bind ourselves, our heirs, executors, administrators, successors and assigns, jointly and severally, firmly by these presents.**

THE CONDITION OF THIS OBLIGATION IS SUCH that if Principal, his or its subcontractors, heirs, executors, administrators, successors or assigns, **shall fail to pay any of the persons named in Section 9100 of the Civil Code**, fail to pay for any materials, provisions or other supplies, used in, upon, for or about the performance of the work contracted to be done, or for any work or labor thereon of any kind, **or amounts due under the Unemployment Insurance Code Section 13020** with respect to work or labor performed under the contract, or for any amounts required to be deducted, withheld, and paid over to the Employment Development Department or Franchise Tax Board from the wages of employees of the contractor and his subcontractors pursuant to Section 18663 of the Revenue and Taxation Code, with respect to such work and labor the Surety or Sureties will pay for the same, in an amount not exceeding the sum herein above specified, and also, in case suit is brought upon this bond, all litigation expenses incurred by the District in such suit, **including reasonable attorney's fees**, court costs, expert witness fees and investigation expenses.

This bond shall inure to the benefit of any of the persons named in Section 9100 of the Civil Code so as to give a right of action to such persons or their assigns in any suit brought upon this bond.

It is further stipulated and agreed that the Surety on this bond shall not be exonerated or released from the obligation of this bond by any change, extension of time for performance, addition, alteration or modification in, to; or of any contract, plans, specifications, or agreement pertaining or relating to any scheme or work of improvement herein above described, or pertaining or relating to the furnishing of labor, materials, or equipment therefore, nor by any change or modification of any terms of payment or extension of the time for any payment pertaining or relating to any scheme or work of improvement herein above described, nor by any rescission or attempted rescission or attempted rescission of the contract, agreement or bond, nor by any conditions precedent or subsequent in the bond attempting to limit the right of recovery of claimants otherwise entitled to recover under any such contract or agreement or under the bond, nor by any fraud practiced by any person other than the claimant seeking to recover on the bond and that this bond be construed most strongly against the Surety and in favor of all persons for whose benefit such bond is given, and under no circumstances shall Surety be released from liability to those for whose benefit such bond has been given, by reason of any breach of contract between the District and original contractor or on the part of any obligee named in such bond, but the sole conditions of recovery shall be that claimant is a person described in Section 9100 of the Civil Code, and has not been paid the full amount of his claim and that Surety does hereby waive notice of any such change, extension of time, addition, alteration or modification herein mentioned and the provisions of Sections 2819 and 2845 of the Civil Code.

IN WITNESS WHEREOF, two (2) identical counterparts of this instrument, each of which shall for all purposes be deemed an original thereof, have been duly executed by the Principal and Surety above named, on the _____ day of _____ 20_____ the name and corporate seal of each corporate party being hereto affixed and these presents duly signed by its undersigned representative pursuant to authority of its governing body.

(Corporate Seal of Principal,
If corporation)

Principal (Property Name of Contractor)

By _____
(Signature of Contractor)

(Seal of Surety)

Surety

By _____
Attorney in Fact

Signatures of those signing for the Contractor and Surety must be notarized and evidence of corporate authority attached. A copy of the Power-of-Attorney to local representatives of the bonding company must be attached hereto.

Insert California All-Purpose Acknowledgment Notary Form

PERFORMANCE BOND

KNOW ALL PERSONS BY THESE PRESENTS:

THAT WHEREAS, Victor Elementary School District (hereinafter referred to as "District") has awarded to _____, (hereinafter referred to as the "Contractor") _____ an agreement for _____ (hereinafter referred to as the "Project").

WHEREAS, the work to be performed by the Contractor is more particularly set forth in the Contract Documents for the Project dated _____, (hereinafter referred to as "Contract Documents"), the terms and conditions of which are expressly incorporated herein by reference; and

WHEREAS, the Contractor is required by the Contract Documents to perform the terms thereof and to furnish a bond for the faithful performance of the Contract Documents.

NOW, THEREFORE, we, _____, the undersigned Contractor and _____ as Surety, a corporation organized and duly authorized to transact business under the laws of the State of California, are held and firmly bound unto the District **in the sum of _____ DOLLARS, (\$ _____), the sum being not less than one hundred percent (100%)** of the total amount of the Contract, for which amount well and truly to be made, **we bind ourselves, our heirs, executors and administrators, successors and assigns, jointly and severally, firmly by these presents.**

THE CONDITION OF THIS OBLIGATION IS SUCH, that, if the Contractor, his or its heirs, executors, administrators, successors or assigns, shall in all things stand to and abide by, and well and truly keep and perform the covenants, conditions and agreements in the Contract Documents and any alteration thereof made as therein provided, on its part, to be kept and performed at the time and in the manner therein specified, and in all respects according to their intent and meaning; and shall faithfully fulfill all obligations including the one-year guarantee of all materials and workmanship; and shall indemnify and save harmless the District, its officers and agents, as stipulated in the Contract Documents, then this obligation shall become null and void; otherwise it shall be and remain in full force and effect.

As a condition precedent to the satisfactory completion of the Contract Documents, unless otherwise provided for in the Contract Documents, the guarantee obligation shall hold good for a period of one (1) year after the acceptance of the work by the District, during which time if Contractor shall fail to make full, complete, and satisfactory repair and replacements and totally protect the District from loss or damage resulting from or caused by defective materials or faulty workmanship, Surety shall undertake and faithfully fulfill all such obligations. The Obligations of Surety hereunder shall continue so long as any obligation of Contractor remains. Nothing herein shall limit the District's rights or the Contractor or Surety's obligations under the Contract, law or equity, including, but not limited to, California Code of Civil Procedure section 337.15.

As a part of the obligation secured hereby and in addition to the face amount specified therefor, there shall be included costs and reasonable expenses and fees **including reasonable attorney's fees**, incurred by District in enforcing such obligation.

Whenever Contractor shall be, and is declared by the District to be, in default under the Contract Documents, the Surety shall remedy the default pursuant to the Contract Documents, or shall promptly, at the District's option:

- (1) Take over and complete the Project in accordance with all terms and conditions in the Contract Documents; or
- (2) Obtain a bid or bids for completing the Project in accordance with all terms and conditions in the

Contract Documents and upon determination by Surety of the lowest responsive and responsible bidder, arrange for a Contract between such bidder, the Surety and the District, and make available as work progresses sufficient funds to pay the cost of completion of the Project, less the balance of the contract price, including other costs and damages for which Surety may be liable. The term "balance of the contract price" as used in this paragraph shall mean the total amount payable to Contractor by the District under the Contract and any modification thereto, less any amount previously paid by the District to the Contractor and any other set offs pursuant to the Contract Documents.

- (3) Permit the District to complete the Project in any manner consistent with local, California and federal law and make available as work progresses sufficient funds to pay the cost of completion of the Project, less the balance of the contract price, including other costs and damages for which Surety may be liable. The term "balance of the contract price" as used in this paragraph shall mean the total amount payable to Contractor by the District under the Contract and any modification thereto, less any amount previously paid by the District to the Contractor and any other set offs pursuant to the Contract Documents.

Surety expressly agrees that the District may reject any contractor or subcontractor which may be proposed by Surety in fulfillment of its obligations in the event of default by the Contractor.

Surety shall not utilize Contractor in completing the Project nor shall Surety accept a bid from Contractor for completion of the Project if the District, when declaring the Contractor in default, notifies Surety of the District's objection to Contractor's further participation in the completion of the Project.

The Surety, for value received, hereby stipulates and agrees that no change, extension of time, alteration or addition to the terms of the Contract Documents or to the Project to be performed thereunder shall in any way affect its obligations on this bond, and it does hereby waive notice of any such change, extension of time, alteration or addition to the terms of the Contract Documents or to the Project.

IN WITNESS WHEREOF, we have hereunto set our hands and seals this _____ day of _____, 20__.

CONTRACTOR/PRINCIPAL

Name

By _____

SURETY:

By: _____
Attorney-In-Fact

Signatures of those signing for the Contractor and Surety must be notarized and evidence of corporate authority attached.

The rate of premium on this bond is _____ per thousand. The total amount of premium charges, \$_____.
(The above must be filled in by corporate attorney.)

THIS IS A REQUIRED FORM

Any claims under this bond may be addressed to:

(Name and Address of Surety)

(Name and Address of Agent or Representative for service of process in California, if different from above)

(Telephone number of Surety and Agent or Representative for service of process in California)

Insert California All-Purpose Acknowledgment Notary Form

GUARANTEE

We hereby guarantee that the _____ which we have installed for the:

West Side Parking Lots & Playgrounds Seal & Stripe # 24-002

at Victor Elementary School District, Victorville, California, has been performed in accordance with the requirements of the Contract Documents and that the work as installed will fulfill the requirements of the Contract Documents.

The undersigned agrees to repair or replace any or all of such work that may prove to be defective in workmanship or material together with any other adjacent work which may be displaced in connection with such replacement within a period of 1 year(s) from the date of acceptance of the above-mentioned project by the Victor Elementary School District, with the exception of ordinary wear and tear and unusual abuse or neglect.

In the event of the undersigned's failure to comply with the above mentioned conditions within a reasonable period of time, as determined by the District, but not Later than one week after being notified in writing by the District, the undersigned authorizes the District to proceed to have said defects repaired and made good at the expense of the undersigned, which will pay the costs and charges therefore upon demand.

SUBCONTRACTOR OR GENERAL CONTRACTOR

Countersigned

GENERAL CONTRACTOR IF FOR
SUBCONTRACTOR

Representatives to be contacted for service subject to terms of contract.

NAME _____

ADDRESS _____

PHONE # _____

INSURANCE DOCUMENTS & ENDORSEMENTS

The following insurance endorsements and documents must be provided to the Victor Elementary School District within five (5) calendar days after receipt of notification of award. If the apparent low bidder fails to provide the documents required below, the District may award the Contract to the next lowest responsible and responsive bidder or release all bidders, and the bidder's bid security will be forfeited. All insurance provided by the bidder shall fully comply with the requirements set forth in Article 11 of the General Conditions.

1. **General Liability Insurance:** Certificate of Insurance with all specific insurance coverages set forth in Article 11 of the General Conditions, proper Project description, designation of the District as the Certificate Holder, a statement that the insurance provided is primary to any insurance obtained by the District and minimum of 30 days' cancellation notice. Bidder shall also provide required additional insured endorsement(s) designating all parties required in Article 11 of the General Conditions. The additional insured endorsement shall be an ISO CG 20 10 (04/13), or an ISO CG 20 38 (04/13), or their equivalent as determined by the District in its sole discretion.

Incidents and claims are to be reported to the insurer at:

Attn: _____
(Title) _____ (Department)

(Company)

(Street Address)

(City) _____ (State) _____ (Zip Code)

(_____) _____
(Telephone Number)

2. **Workers' Compensation/ Employer's Liability Insurance:** Certificate of Workers' Compensation Insurance meeting the coverages and requirements set forth in Article 11 of the General Conditions, minimum of 30 days' cancellation notice, proper Project description, waiver of subrogation and any applicable endorsements.

3. **Automobile Liability Insurance:** Certificate of Automobile Insurance meeting the coverages and requirements set forth in Article 11 of the General Conditions, minimum 30 days' cancellation notice, any applicable endorsements and a statement that the insurance provided is primary to any insurance obtained by the District.

Incidents and claims are to be reported to the insurer at:

Attn: _____
(Title) (Department)

(Company)

(Street Address)

(City) (State) (Zip Code)

(Telephone Number)

DATE: _____ CONTRACTOR _____

By: _____
Signature

CONTRACTOR CERTIFICATION REGARDING BACKGROUND CHECKS

_____ certifies that it has performed one of the following:
[Name of contractor/consultant]

- Pursuant to Education Code Section 45125.1, Contractor has conducted criminal background checks, through the California Department of Justice, of all employees providing services to the Victor Elementary School District, pursuant to the contract/purchase order dated _____, and that none have been convicted of serious or violent felonies, as specified in Penal Code Sections 1192.7(c) and 667.5(c), respectively.

As further required by Education Code Section 45125.1, attached hereto as Attachment "A" is a list of the names of the employees of the undersigned who may come in contact with pupils.

OR

- Pursuant to Education Code Section 45125.2, Contractor will ensure the safety of pupils by one or more of the following methods:
 - (1) The installation of a physical barrier at the worksite to limit contact with pupils.
 - (2) Continual supervision and monitoring of all employees of the entity by an employee of the entity whom the Department of Justice has ascertained has not been convicted of a violent or serious felony.

I declare under penalty of perjury under the laws of the United States that the foregoing is true and correct.

Date _____, 20____

[Name of Contractor/Consultant]

By its: _____

ATTACHMENT "A"

*(LIST OF THE NAMES OF EMPLOYEES WHO MAY COME IN
CONTACT WITH PUPILS) DESIGNATION OF EMPLOYEES*

EMPLOYEE NAME

EMPLOYER NAME
CONTRACTOR / SUBCONTRACTOR

EMPLOYEE NAME	EMPLOYER NAME CONTRACTOR / SUBCONTRACTOR

CONTRACT REQUIREMENTS



Erickson-Hall **Construction**
An Employee Owned Company

11810 Pierce St, Unit 150 Riverside, CA 92505. T: 951.358.0738

EHCC PROJECT NO. 4403

GENERAL CONDITIONS

Article 1. DEFINITIONS

- A. Action of the Governing Board is a majority vote of a quorum at a lawful meeting.
- B. Approval, Approved means written authorization by DISTRICT for specific applications within the Contract.
- C. As shown, as indicated, as detailed refers to drawings accompanying this specification.
- D. Contract, Contract Documents includes all contract documents to wit: Notice inviting Bids, Instructions to Bidders, Bid Form, Designation of Subcontractors, Performance and Payment Bonds, General Conditions, Drawings, Plans, Specifications, the Agreement and all modifications, addenda, and amendments thereto.
- E. Contractor, District are those mentioned as such in the Agreement. They are treated throughout the contract as if they are of singular number and neuter gender.
- F. Locality in which the work is performed means the county in which the public work is done.
- G. Project is the planned undertaking as provided for in the contract documents by DISTRICT and CONTRACTOR.
- H. Provide shall include "provide complete in place", that is, "furnish & install".
- I. Safety Orders are those issued by the Division of Industrial Safety an OSHA Safety and Health Standards for construction.
- J. Standards, Rules and Regulations referred to are recognized printed standards and shall be considered as one and a part of these specifications within limits specified.
- K. Subcontractor, as used herein, includes those having direct contract with CONTRACTOR and one who furnishes material worked to a special design according to plans, drawings, and specifications for this work, but does not include one who merely furnishes material not so worked.
- L. Surety is the person, firm, or corporation that executes as surety the CONTRACTOR's Payment Bond.
- M. Work of the CONTRACTOR or subcontractor includes labor or materials (including, without installation, equipment and appliances) or both, incorporated in, or to be incorporated in the construction covered by the complete Contract.
- N. Workers includes laborer, worker or mechanic.

Article 2. LAWS CONCERNING THE DISTRICT A PART HEREOF

Contract is subject to all provision of the Constitution of Laws of California governing, controlling or effecting DISTRICT, or the property, funds operations, or powers of DISTRICT, and such provisions are by his reference made a part hereof and of Contract.

Article 3. SITE INVESTIGATION

Before bidding on this work, CONTRACTOR shall make a careful investigation of the site and thoroughly familiarize himself with the requirement of the Contract. By the act of submitting a bid for the work included in this Contract, CONTRACTOR shall be deemed to have made such study and investigation and that CONTRACTOR is familiar with and accepts the conditions of the site.

Article 4. STATUS OF CONTRACTOR

CONTRACTOR is and shall at all times be deemed to be an independent CONTRACTOR and shall be wholly responsible for the manner in which it performs the services required of it by the terms of this contract. Nothing herein contained shall be construed as creating the relationship of employer and employee, or principal and agent, between the DISTRICT, or any of the DISTRICT's employees or agents, and CONTRACTOR or any of CONTRACTOR's agents or

employees. CONTRACTOR assumes exclusively the responsibility for the acts of its employees as they relate to the services to be provided during the course and scope of their employment. CONTRACTOR, its agents and employees shall not be entitled to any rights or privileges of DISTRICT employees. DISTRICT shall be permitted to monitor the activities to determine compliance with the terms of this Contract. CONTRACTORS and subcontractors are required by law to be licensed and regulated by the Contractors State License Board.

Article 5. CONTRACTOR’S SUPERVISION

A. The CONTRACTOR shall verify all indicated dimensions before ordering materials or equipment, or before performing work. The CONTRACTOR shall take field measurements, verify field conditions, and shall carefully compare such field measurements and conditions and other information known to the CONTRACTOR with the contract documents before commencing activities. Errors, inconsistencies, or omissions discovered shall be reported to the District at once. Upon commencement of any item of work, the CONTRACTOR shall be responsible for dimensions related to such item of work and shall make any corrections necessary to make work properly fit at no additional cost to DISTRICT. This responsibility for verification of dimensions is a non-delegable duty and may not be delegated to subcontractors or agents.

B. Omissions from the drawings or specifications, or the misdescription of details of work which are manifestly necessary to carry out the intent of the drawings and specifications, or which are customarily performed, shall not relieve the CONTRACTOR from performing such omitted or misdescribed work, but they shall be performed as if fully and correctly set forth and described in the drawings and specifications.

C. The CONTRACTOR must provide a Supervisor available on the work site at all times who can understand and communicate with all Victor Elementary School District Supervisors.

Article 6. SUBCONTRACTORS

A. CONTRACTOR agrees to bind every subcontractor by terms of Contract as far as such terms are applicable to subcontractor’s work. If CONTRACTOR shall subcontract any part of this Contract, CONTRACTOR shall be as fully responsible to DISTRICT for acts and omissions of any subcontractor and of persons either directly or indirectly employed by any subcontractor, as it is for acts and omissions of persons directly employed by CONTRACTOR. Nothing contained in the contract documents shall create any contractual relation between any subcontractor and DISTRICT, nor shall this Contract be construed to be for the benefit of any subcontractor.

B. The CONTRACTOR shall be responsible for the coordination of the trades, subcontractors and materialmen engaged upon his work.

Article 7. DISTRICT’S INSPECTOR

If applicable, one or more Inspector(s), including special Inspectors, as required, will be employed by DISTRICT in accordance with requirements of Title 24 (previously Title 21) of the California Code of Regulations and will be assigned to the work. Duties of an Inspector are specifically defined in Section 4-342 (previously Section 42) of said Title 24. No work shall be carried on except with the knowledge and under the inspection of said Inspector(s). He shall have free access to any or all parts of work at any time. The DISTRICT will provide inspection and testing at its cost during the normal eight (8) hour day Monday through Friday (except holidays). Work by the CONTRACTOR outside of the normal eight (8) hour day shall constitute an authorization from the CONTRACTOR to the DISTRICT to provide inspection and testing as required outside of the normal eight (8) hour day. CONTRACTOR shall reimburse DISTRICT for inspection and testing outside the normal eight-hour day or for any retests caused by the CONTRACTOR.

Article 8. ASSIGNMENT OF ANTITRUST ACTIONS

A. Pursuant to Government Code § 4551, in entering into a public works contract or a subcontract to supply goods, services, or materials pursuant to a public works contract, the CONTRACTOR or Subcontractor offers and agrees to assign to the DISTRICT all rights, title, and interest in and to all causes of action it may have under Section 4 of the Clayton Act, (15 U.S.C. § 15) or under the Cartwright Act (Chapter 2 [commencing with § 16700] of Part 2 of Division 7 of the Business and Professions Code), arising from the purchase of goods, services, or materials pursuant to the public works

contract or the subcontract. This assignment shall be made and become effective at the time the awarding body tenders final payment to the CONTRACTOR, without further acknowledgment by the parties. If the DISTRICT receives, either through

judgment or settlement, a monetary recovery for a cause of action assigned under Chapter 11 (commencing with § 4550) of Division 5 of Title 1 of the Government Code, the assignor shall be entitled to receive reimbursement for actual legal costs incurred and may, upon demand, recover from the DISTRICT any portion of the recovery, including treble damages, attributable to overcharges that were paid by the assignor but were not paid by the DISTRICT as part of the bid price, less the expenses incurred in obtaining that portion of the recovery.

B. Upon demand in writing by the assignor, the DISTRICT shall, within one (1) year from such demand, reassign the cause of action assigned pursuant to this Article if the assignor has been or may have been injured by the violation of law for which the cause of action arose and the DISTRICT has not been injured thereby or the DISTRICT declines to file a court action for the cause of action.

Article 9. OTHER CONTRACTS

A. DISTRICT reserves the right to let other contracts in connection with this work. CONTRACTOR shall afford other contractors reasonable opportunity for introduction and storage of their materials and execution of their work and shall properly connect and coordinate its work with theirs.

B. Nothing herein contained shall be interpreted as granting to CONTRACTOR exclusive occupancy at the Project site. CONTRACTOR shall not cause any unnecessary hindrance or delay to any other contractor working on Project. If simultaneous execution of any Contract for Project is likely to cause interference with performance of some other contract or contracts, DISTRICT shall decide which contractor shall cease work temporarily and which contractor shall continue or whether work can be coordinated so that contractors may proceed simultaneously.

Article 10. OCCUPANCY

DISTRICT reserves the right to occupy portions of the Project at any time before completion, and such occupancy shall constitute final acceptance of that portion only to the extent that the CONTRACTOR will not be subject to performing work or repairs caused by the DISTRICT’s use of the occupied areas. Such occupancy shall not extend the date specified for completion of the work. The CONTRACTOR will be required to complete punch list items documented by DISTRICT, Architect, Inspector and CONTRACTOR prior to final payment.

Article 11. DISTRICT’S RIGHT TO DO WORK

Should the CONTRACTOR, at any time during the process of construction, fail or refuse to furnish enough materials or workmen to properly execute the work, unless prohibited from so doing through the action of DISTRICT or other authorized official agencies, DISTRICT, after giving ten (10) days written notice to CONTRACTOR may, without prejudice to any other rights he may have, proceed to furnish the materials and/or workmen necessary to proceed with or complete the work, and may deduct the cost thereof, together with reasonable expenses arising from such procedure, from any amounts then due or which may thereafter become due to CONTRACTOR.

Article 12. DISTRICT’S RIGHT TO TERMINATE CONTRACT

A. **Grounds for Termination.** The CONTRACTOR may terminate the Contract if the Work is stopped for a period of thirty (30) consecutive days through no act or fault of the CONTRACTOR, a Subcontractor, their agents or employees, or any other persons performing portions of the Work for whom the CONTRACTOR is contractually responsible, for only the following reasons:

- (1) Issuance of an order of a court or other public authority having jurisdiction; or
- (2) An act of government, such as a declaration of national emergency.

B. **Notice of Termination.** If one of the above reasons exists, the CONTRACTOR may, upon written notice of seven (7) additional days to the DISTRICT, terminate the Contract and recover from the DISTRICT payment for Work

executed and for reasonable costs verified by the District with respect to materials, equipment, tools, construction equipment, and machinery, including reasonable overhead, profit, and damages.

Article 13. TERMINATION BY THE DISTRICT FOR CAUSE

A. **Grounds for Termination.** The DISTRICT may terminate the Contract if the CONTRACTOR:

- (1) Persistently or repeatedly refuses or fails to supply enough properly skilled workers or proper materials;
- (2) Persistently or repeatedly is absent, without excuse, from the job site;
- (3) Fails to make payment to Subcontractors;
- (4) Persistently disregards laws, ordinances, rules, regulations, or orders of a public authority having jurisdiction;
or
- (5) Otherwise is in substantial breach of a provision of the Contract Documents.

B. **Notification of Termination.** When any of the above reasons exist, the DISTRICT may, without prejudice to any other rights or remedies of the DISTRICT and after giving the CONTRACTOR and the CONTRACTOR's surety, if any, written notice of seven (7) days, terminate the Contract and may, subject to any prior rights of the surety:

- (1) Take possession of the Project and of all material, equipment, tools, and construction equipment and machinery thereon owned by the CONTRACTOR;
- (2) Accept assignment of Subcontracts; and
- (3) Complete the Work by any reasonable method the DISTRICT may deem expedient.

C. **Payments Withheld.** If the DISTRICT terminates the Contract for one of the reasons stated in Article 17.1 A, the CONTRACTOR shall not be entitled to receive further payment until the Work is complete.

D. **Payments Upon Completion.** If the unpaid balance of the Contract Sum exceeds costs of completing the Work, including compensation for professional services and expenses made necessary thereby, such excess shall be paid to the CONTRACTOR. If such costs exceed the unpaid balance, the CONTRACTOR shall pay the difference to the DISTRICT. The amount to be paid to the CONTRACTOR, or DISTRICT, as the case may be, shall be certified by the District upon application. This payment obligation shall survive completion of the Contract.

Article 14. TERMINATION OF CONTRACT BY DISTRICT (CONTRACTOR NOT AT FAULT)

DISTRICT may terminate the Contract upon fifteen (15) calendar days of written notice to the CONTRACTOR, if it is found that reasons beyond the control of either the DISTRICT or CONTRACTOR make it impossible or against the DISTRICT's interest to complete the work. In such a case, the CONTRACTOR shall have no claims against the DISTRICT except: (1) the actual cost for labor, materials, and services performed which may be documented through timesheets, invoices, receipts, or otherwise, and (2) ten percent (10%) profit and overhead, and (3) five percent (5%) termination cost of the total of items (1) and (2).

Article 15. PAYMENT BOND

A. **Bond Requirements.** Prior to commencing any portion of the Work, the CONTRACTOR shall furnish a payment and performance bond for its portion of the Work which shall cover 100% faithful payment of all obligations arising under the Contract Documents and/or guaranteeing the payment in full of all claims for labor performed and materials supplied for the Work. All bonds shall be provided by a corporate surety authorized and admitted to transact business in California as sureties.

B. To the extent, if any, that the Contract Price is increased in accordance with the Contract Documents, the CONTRACTOR shall, upon request of the DISTRICT, cause the amount of the bonds to be increased accordingly and shall promptly deliver satisfactory evidence of such increase to the DISTRICT. To the extent available, the bonds shall further provide that no change or alteration of the Contract Documents (including, without limitation, an increase in the Contract Price, as referred to above), extensions of time, or modifications of the time, terms, or conditions of payment to the CONTRACTOR will release the surety. If the CONTRACTOR fails to furnish the required bonds, the DISTRICT may terminate the Contract for cause.

C. **Surety Qualifications.** Only bonds executed by admitted Surety insurers as defined in Code of Civil Procedure § 995.120 shall be accepted. Surety must be a California-admitted surety and listed by the U.S. Treasury with a bonding capacity in excess of the Project cost.

D. **Alternate Surety Qualifications.** If a California-admitted surety insurer issuing bonds does not meet these requirements, the insurer will be considered qualified if it is in conformance with § 995.660 of the California Code of Civil Procedure and proof of such is provided to the DISTRICT.

Article 16. DRAWINGS AND SPECIFICATIONS

A. Contract Documents are complementary, and what is called for by one shall be as binding as if called for by all.

B. Materials or work described in words which so applied has a well known technical or trade meaning shall be deemed to refer to such recognized standards.

C. It is not the intention of the Contract to go into detailed descriptions of any materials and/or methods commonly known to the trade under the "trade name" or "trade term." The mere mention or notation of such "trade name" or "trade term" shall be considered a sufficient notice to CONTRACTOR that it will be required to complete the work so named with all its appurtenances according to the best practices of the trade.

D. The naming of any material and/or equipment shall mean furnishing and installing of same, including all incidental and accessory items thereto and/or labor therefor, as per best practices of the trade(s) involved, unless specifically noted otherwise.

E. Figured dimensions on drawings shall govern, but work not dimensioned shall be as directed. Work not particularly shown or specified shall be the same as similar parts that are shown or specified. Large-scale details shall take precedence over smaller scale drawings as to shape and details of construction. Specifications shall govern as to materials, workmanship, and installations procedures. Drawings and specifications are intended to be fully cooperative and to agree. However, if CONTRACTOR observes that drawings and specifications are in conflict, CONTRACTOR shall promptly notify the DISTRICT in writing, and any necessary changes shall be adjusted as provided in the Article entitled "Changes and Extra Work." The specification calling for the higher quality material or workmanship shall prevail.

F. Specifications and accompanying drawings are intended to delineate and describe the Project and its component parts to such a degree as to enable skilled and competent CONTRACTORS to intelligently bid upon the work, and to carry said work to a successful conclusion.

G. Drawings and specifications are intended to comply with all laws, ordinances, rules, and regulations of constituted authorities having jurisdiction, and where referred to in the contract documents, said laws, ordinances, rules, and regulations shall be considered as a part of said Contract within the limits specified. The CONTRACTOR shall bear all

expenses of correcting work done contrary to said laws, ordinances, rules, and regulations if the CONTRACTOR knew or should have known that the work as performed is contrary to said laws, ordinances, rules, and regulations and if the CONTRACTOR performed same (1) without first consulting the District for further instructions regarding said work or (2) disregarded the District's instructions regarding said work.

H. Questions regarding interpretation of drawings and specifications shall be clarified by the District. Should the CONTRACTOR commence work or any part thereof without seeking clarification, CONTRACTOR waives any claim for extra work or damages as a result of any ambiguity, conflict, or lack of information.

I. CONTRACTOR will be furnished, free of charge, bid sets of permitted documents and specifications. CONTRACTOR is to provide reproducible drawings and all additional copies which he requires for his operations at his own expense. He shall maintain an accurate record of all copies made and shall return or otherwise account for all copies at the end of the Project.

Article 17. OWNERSHIP OF DRAWINGS

Pursuant to Education Code section 17316, all plans, drawings, designs, specifications, and other incidental architectural and engineering work or materials and other contract documents and copies thereof furnished by DISTRICT are its property. They are not to be used in other work and, with the exception of signed sets of the Contract, are to be returned to the DISTRICT on request at completion of work.

Article 18. DETAIL DRAWINGS AND INSTRUCTIONS

A. In case of ambiguity, conflict, or lack of information, District shall furnish, with reasonable promptness, additional instructions by means of drawings or otherwise, necessary for proper execution of work. All such drawings and instructions shall be consistent with contract documents, true developments thereof, and reasonably inferable therefrom.

B. Work shall be executed in conformity therewith and CONTRACTOR shall do no work without proper drawings and instructions.

C. The District will furnish necessary details to more fully explain the work, which details shall be considered as part of the contract documents.

D. Should any details require work and costs beyond those which reasonably should have been included in the contract, CONTRACTOR shall give written notice thereof to the DISTRICT within ten (10) working days of the receipt of same. In case no notice is given to the DISTRICT within ten (10) working days, it will be assumed the details are reasonable development of the scale drawings. In case notice is given, then the claim will be considered and, if found justified, the DISTRICT or Architect will either modify the drawings or shall recommend to DISTRICT a change order for the extra work involved.

E. All parts of the described and shown construction shall be of the quality of their respective kinds shown in the Plans or as specified, and the CONTRACTOR is hereby advised to use all diligence to become fully informed as to the required construction and finish, and in no case to proceed with the different parts of the work without first obtaining from the District some directions and/or drawings as may be necessary for the proper performance of the work.

F. If it is found at any time, before or after completion of the work, that the CONTRACTOR has varied from the drawings and/or specifications, in materials, quality, form, or finish, or in the amount or value of the materials and labor used, the DISTRICT shall issue an order to CONTRACTOR: (1) that all such improper work should be removed, remade, and replaced, and all work disturbed by these changes be made good at the CONTRACTOR's expense; or (2) that the DISTRICT deduct from any amount due CONTRACTOR, the sum of money equivalent to the difference in value between the work performed and that called for by the drawings and specifications. DISTRICT shall in its sole discretion determine such difference in value. The DISTRICT, at its option, may pursue either course.

Article 19. STATE AUDIT

Pursuant to and in accordance with the provisions of Government Section 10532, or any amendments thereto, all books, records, and files of DISTRICT, CONTRACTOR, or any subcontractor connected with the performance of this Contract involving the expenditure of state funds in excess of ten thousand dollars (\$10,000.00), including, but not limited to, the administration thereof, shall be subject to the examination and audit of the Office of the Auditor General of the State of California for a period of three (3) years after final payment is made under this Contract. CONTRACTOR shall preserve and cause to be preserved such books, records and files for the audit period.

Article 20. MATERIALS AND WORK

A. Except as otherwise specifically stated in this Contract, CONTRACTOR shall provide and pay for all materials, labor, tools, equipment, transportation, superintendence, temporary constructions of every nature, and all other services and facilities of every nature whatsoever necessary to execute and complete this Contract within specified time.

B. Unless otherwise specified, all materials shall be new and shall be of the respective kinds and grades as noted or specified.

C. Materials shall be furnished in ample quantities and at such times as to insure uninterrupted progress of work and shall be stored properly and protected as required. CONTRACTOR shall be entirely responsible for damages or loss by weather or other causes to materials or work under this Contract.

D. CONTRACTOR shall, after award of Contract by DISTRICT, place orders for materials and/or equipment as specified so that delivery of same may be made without delays to the work. CONTRACTOR shall, upon demand from the DISTRICT, furnish to the DISTRICT documentary evidence showing that orders have been placed.

E. No material, supplies, or equipment for work under this Contract shall be purchased subject to any chattel mortgage or under a conditional sale or other agreement by which an interest therein or in any part thereof is retained by seller or supplier. CONTRACTOR warrants good title to all material, supplies, and equipment installed or incorporated in work and agrees upon completion of all work to deliver premises, together with all improvements and appurtenances constructed or placed thereon by it, to DISTRICT free from any claims, liens, or charges. CONTRACTOR further agrees that neither it nor any person, firm, or corporation furnishing any materials or labor for any work covered by this Contract shall have any right to place a lien upon the premises or any improvement or appurtenance thereof, except that CONTRACTOR may install metering devices or other equipment of a utility company or political subdivision, title to which is commonly retained by the utility company or political subdivision. In event of installation of any such metering device or equipment, CONTRACTOR shall advise DISTRICT as to its owner.

F. For all material and equipment specified or indicated in the Drawings, the CONTRACTOR shall provide all labor, materials, equipment, and services necessary for complete assemblies and complete working systems. Incidental items not indicated on the Drawings, nor mentioned in the Specifications, that can legitimately and reasonably be inferred to belong to the work described, or be necessary in good practice to provide a complete assembly or system, shall be furnished as though itemized here in every detail. In all instances, material and equipment shall be installed in strict accordance with each manufacturer's most recent published recommendations and specifications.

Article 21. OBTAINING OF PERMITS, LICENSES AND EASEMENTS

Permits, licenses, and certificates necessary for prosecution of work shall be secured and paid for by CONTRACTOR, unless otherwise specified. All such permits, licenses, and certificates shall be delivered to District before demand is made for the certificates of final payment. CONTRACTOR shall, and shall require subcontractors to, maintain CONTRACTOR's licenses in effect as required by law.

Article 22. ACCESS TO WORK

DISTRICT and its representatives shall at all times have access to work wherever it is in preparation or progress. CONTRACTOR shall provide safe and proper facilities for such access so that DISTRICT's representatives may perform their functions.

Article 23. SANITARY FACILITIES

If applicable, CONTRACTOR shall provide sanitary temporary facilities in no fewer numbers than required by law.

Article 24. CLEANING UP

CONTRACTOR at all times shall keep premises free from debris such as waste, rubbish, and excess materials and equipment caused by the work. CONTRACTOR shall not leave debris under, in, or about the premises, but shall promptly remove same from the premises. Upon completion of work, CONTRACTOR shall clean interior and exterior of building, including fixtures, equipment, walls, floors, ceilings, roofs, window sills and ledges, horizontal projections, and any areas where debris has collected so surfaces are free from foreign material or discoloration; CONTRACTOR shall clean and polish all glass, plumbing fixtures, and finish hardware and similar finish surfaces and equipment and remove temporary fencing, barricades, planking, sanitary facilities and similar temporary facilities from site. If CONTRACTOR fails to clean up, DISTRICT may do so and the cost thereof shall be charged to CONTRACTOR.

Article 25. GUARANTEE

A. In addition to guarantees required elsewhere, CONTRACTOR shall, and hereby does guarantee all work furnished on the job against all defects for a period of one year after date of acceptance of work by DISTRICT and shall repair or replace any and all such work, together with any other work, which may be displaced in so doing that may prove defective in workmanship and/or materials within one year period from date of acceptance without expense whatsoever to DISTRICT, ordinary wear and tear, unusual abuse or neglect excepted. DISTRICT will give notice of observed defects to CONTRACTOR and Surety with reasonable promptness. CONTRACTOR shall notify DISTRICT upon completion of such repairs or replacement.

B. CONTRACTOR warrants that the WORK (which includes any equipment furnished by CONTRACTOR as a part of the materials) shall: (a) Be free from defects in workmanship and material; (b) Be free from defects in any design performed by CONTRACTOR; (c) Be new, and conform and perform to the requirements stated in the Specifications, and where detail requirements are not so stated, shall conform to applicable industry standards; and (d) Be suitable for the use stated in the Specifications.

C. The warranty period for discovery of DEFECTIVE WORK shall commence on the date stamped on the Notice of Completion verifying County registration and continue for the period set forth in the Specifications or for one year if not so specified. If, during the warranty period, the WORK is not available for use due to DEFECTIVE WORK, such time of unavailability shall not be counted as part of the warranty period. The warranty period for corrected DEFECTIVE WORK shall continue for a duration equivalent to the original warranty period.

Article 26. DUTY TO PROVIDE FIT WORKERS

A. CONTRACTOR and Subcontractors shall at all times enforce strict discipline and good order among their employees and shall not employ on work any person not skilled in the work assigned to such person. It shall be the responsibility of CONTRACTOR to insure compliance with this article.

B. Any person in the employ of the CONTRACTOR or subcontractors whom DISTRICT may deem unfit shall be excluded from the work site and shall not again be employed on it except with written consent of DISTRICT. As used in this subsection, "unfit" means any person who the DISTRICT concludes is either not, or improperly, skilled for the task assigned to that person, who fails to comply with the requirements of this article, or who creates safety hazards that jeopardize other persons and/or property.

C. CONTRACTOR shall take all reasonable steps necessary to insure that any employees of CONTRACTOR or any of its subcontractors employees do not use, consume, or work under the influence of any alcohol or illegal drugs while on the Project. CONTRACTOR shall further prevent any of its employees or its subcontractor employees from playing any recorded music devices or radios or wearing any radio headphone devices for entertainment while working on the Project. Likewise, CONTRACTOR shall preclude any of its employees or subcontractor's employees from bringing any animal onto the Project.

Article 27. FINGERPRINTING

A. If applicable, CONTRACTOR shall comply with all provisions of either Education Code Section 45125.1 or 45125.2. Pursuant to Education Code Section 45125.1, CONTRACTOR shall conduct criminal background checks of all employees of CONTRACTOR assigned to the DISTRICT, and shall certify that no employees who have been convicted of serious or violent felonies, as specified in Education Code Section 45125.1, will have contact with pupils, by utilizing the certification attached hereto as Exhibit "A". As part of such certification, CONTRACTOR must provide the DISTRICT with a list of all employees providing services pursuant to this Agreement, and designate which sites such employees will be assigned. In performing the services set forth in this Agreement, CONTRACTOR shall not utilize any employees who are not included on the above-referenced list. At DISTRICT's sole discretion, DISTRICT may make a finding, as authorized under Education Code section 45125.1, that CONTRACTOR's employees will have only "limited contact" with pupils. CONTRACTOR's failure to comply with this law shall be considered a material breach of this Agreement upon where this Agreement may be terminated, at DISTRICT's sole discretion, without any further compensation to CONTRACTOR.

B. Pursuant to section 45125.2 CONTRACTOR shall ensure the safety of pupils by the installation of a physical barrier at the worksite and by continual supervision and monitoring of all these employees by an employee of CONTRACTOR whom

the Department of Justice has ascertained has not been convicted of a serious or violent felony, as defined in Education Code section 45125.2 (c).

Article 28. WAGE RATES, TRAVEL AND SUBSISTENCE

A. Pursuant to the provisions of Article 2 (commencing at Section 1770), Chapter 1, Part 7, Division 2 of the Labor Code of California, the governing body of DISTRICT has obtained the general prevailing rate of per diem wages and the general prevailing rate for holiday and overtime work in the locality in which this public work is to be performed for each craft, classification or type of worker needed to execute this Contract from the Director of the Department of Industrial Relations (hereinafter, in this article "Director"). These rates are on file with the Director of Purchasing of DISTRICT and copies will be made available to any interested party on request. CONTRACTOR shall post a copy of such wage rates at the job site.

B. Holiday and overtime work, when permitted by law, shall be paid for at a rate of at least one and one-half times the above specified rate of per diem wages, unless otherwise specified. Holidays shall be as defined in the Collective Bargaining Agreement applicable to each particular craft, classification or type of worker employed under Contract.

C. CONTRACTOR shall pay and shall cause to be paid each worker engaged in work on the Project not less than the general prevailing rate of per diem wages determined by the Director, regardless of any contractual relationship which may be alleged to exist between CONTRACTOR or any subcontractor and such workers.

D. CONTRACTOR shall pay and shall cause to be paid to each worker needed to execute the work on the Project travel and subsistence payments, as such travel and subsistence payments are defined in the applicable collective bargaining agreements filed with the Department of Industrial Relations in accordance with Labor Code Section 1773.8.

E. If during the period this bid is required to remain open, the Director of Industrial Relations determines that there has been a change in any prevailing rate of per diem wages in the locality in which the work under Contract is to be performed, such change shall not alter the wage rates in the Notice to CONTRACTORS or the Contract subsequently awarded.

F. Pursuant to Labor Code Section 1775, CONTRACTOR shall as a penalty to DISTRICT, forfeit fifty-dollars (\$50.00) for each calendar day, or portion thereof, for each worker paid less than the prevailing rates, determined by the Director, for such work or craft in which such worker is employed for any public work done under Contract by CONTRACTOR or by any subcontractor under it. The difference between such prevailing wage rates and the amount paid to each worker for each calendar day or portion thereof for which each worker was paid less than the prevailing wage rate shall be paid to each worker by CONTRACTOR.

G. Any worker employed to perform work on the Project, which work is not covered by any classification listed in the general prevailing wage rate of per diem wages determined by the Director shall be paid not less than the minimum rate of wages specified therein for the classification which most nearly corresponds to work to be performed by him, and such minimum wage rate shall be retroactive to time of initial employment of such person in such classification.

H. Pursuant to Labor Code Section 1773.1, per diem wages are deemed to include employer payments for health and welfare, pension, vacation, travel time, and subsistence pay as provided for in Labor Code Section 1773.8.

I. CONTRACTOR shall post at appropriate conspicuous points on the site of Project, a schedule showing all determined minimum wage rates and all authorized deductions, if any, from unpaid wages actually earned.

Article 29. HOURS OF WORK

A. As provided in Article 3, (commencing at Section 1810), Chapter 1, Part 7, Division 2 of the Labor Code, eight (8) hours of labor shall constitute a legal days work. The time of service of any worker employed at any time by CONTRACTOR or by any subcontractor on any subcontract under this Contract upon the work or upon any part of the work contemplated by this Contract shall be limited and restricted by CONTRACTOR to eight (8) hours per day, and forty (40) hours during any one week, except as hereinafter provided. Notwithstanding the provisions herein above set forth, work performed by employees of CONTRACTOR in excess of eight (8) hours per day and forty (40) hours during any one week, shall be permitted upon this public work upon compensation for all hours worked in excess of eight (8) hours per day at not less than one and one-half times the basic rate of pay.

B. CONTRACTOR shall keep and shall cause each subcontractor to keep an accurate record showing the name of and actual hours worked each calendar day and each calendar week by each worker employed by CONTRACTOR in connection with the work or any part of the work contemplated by this Contract. The record shall be kept open at all reasonable hours to the inspection of DISTRICT and to the Division of Labor Standards Enforcement, Department of Industrial Relations of the State of California.

C. Pursuant to Labor Code Section 1813, CONTRACTOR shall pay to the DISTRICT a penalty of twenty-five dollars (\$25.00) for each worker employed in the execution of this Contract by CONTRACTOR or by any subcontractor for each calendar day during which such worker is required or permitted to work more than eight (8) hours in any one calendar day and forty (40) hours in any one calendar week in violation of the provisions of Article 3 (commencing at Section 1810), Chapter 1, Part 7, Division 2 of the Labor Code.

D. Any work necessary to be performed after regular working hours, or other holidays shall be performed without additional expense to the DISTRICT.

Article 30. TIME CONSTRAINTS WHILE CHILDREN ARE IN SCHOOL.

Work at the school sites must be done while students are not in the classrooms. The District will provide to the successful bidder a schedule of when students will not be in the classrooms.

Article 31. PAYROLL RECORDS

A. Pursuant to the provisions of Section 1776 of the Labor Code, CONTRACTOR shall keep and shall cause each subcontractor performing any portion of the work under this Contract to keep an accurate payroll record, showing the name, address, social security number, work classification, straight time and overtime hours worked each day and week, and the actual per diem wages paid to each journeyman, apprentice, worker, or other employee employed by CONTRACTOR in connection with the work.

B. The payroll enumerated under subdivision (a) shall be certified and shall be available for inspection at all reasonable hours at the principal office of CONTRACTOR on the following basis:

- (1) A certified copy of an employee’s payroll record shall be made available for inspection or furnished to the employee or his/her authorized representative on request.
- (2) A certified copy of all payroll records enumerated in subdivision (a) shall be made available for inspection or furnished upon request to a representative of DISTRICT, Division of Labor Standards Enforcement, and Division of Apprenticeship Standards of the Department of Industrial Relations.
- (3) A certified copy of all payroll records enumerated in subdivision (a) shall be made available upon request by the public for inspection or copies thereof made; provided, however, that a request by the public shall be made through either the body awarding Contract, Division of Apprenticeship Standards, or the division of Labor Standards Enforcement. If the requested payroll records have not been provided pursuant to paragraph 2 above, the requesting party shall, prior to being provided the records, reimburse the costs of preparation by CONTRACTOR, subcontractors, and the entity through which the request was made. The public shall not be given access to the records at the principal office of CONTRACTOR.
- (4) The form of certification shall be as follows:

I, _____(Name-print), the undersigned, am _____ (position in business) with the authority to act or and on behalf of _____(Name of business and/or contractor), certify under penalty of perjury that the records or copies thereof submitted and consisting of _____ (description, number of pages) are the originals or true, full and correct copies of the originals which depict the payroll record(s) of the actual disbursements by way of cash, check or whatever form to the individual or individuals named.
 Date _____ Signature _____

C. Each CONTRACTOR shall file a certified copy of the records enumerated in subdivision (a) with the entity that requested the records within ten (10) days after receipt of a written request

D. Any copy of records made available for inspection as copies and furnished upon request to the public or any public agency by DISTRICT, Division of Apprenticeship Standards, or Division of Labor Standards Enforcement shall be marked or obliterated in such a manner as to prevent disclosure of an individual's name, address, and social security number. The name and address of CONTRACTOR awarded Contract or performing Contract shall not be marked or obliterated.

E. CONTRACTOR shall inform DISTRICT of the location of the records enumerated under subdivision (a), including the street address, city and county, and shall, within five (5) working days, provide a notice of a change of location and address.

F. In the event of noncompliance with the requirements of this section, CONTRACTOR shall have ten (10) days in which to comply subsequent to receipt of written notice specifying in what respects CONTRACTOR must comply with this section. Should noncompliance still be evident after the ten (10) day period, CONTRACTOR shall, as a penalty to DISTRICT, forfeit twenty-five dollars (\$25.00) for each calendar day, or portion thereof, for each worker, until strict compliance is effectuated. Upon the request of Division of Apprenticeship Standards or Division of Labor Standards Enforcement, these penalties shall be withheld from progress payments then due.

G. It shall be the responsibility of CONTRACTOR to ensure compliance with the provisions of Labor Code section 1776.

Article 32. LABOR - FIRST AID

The CONTRACTOR shall maintain emergency first aid treatment for CONTRACTOR's workers on the Project which complies with current Occupational Safety and Health regulations.

Article 33. PROTECTION OF PERSONS AND PROPERTY

A. The CONTRACTOR shall be responsible for all damages to persons or property that occur as a result of its fault or negligence in connection with the prosecution of this Contract and shall take all necessary measures and be responsible for the proper care and protection of all materials delivered and work performed until completion and final acceptance by the DISTRICT. All work shall be solely at the CONTRACTOR's risk, with the exception of damage to the work caused by "acts of God" as defined in Government Code section 4151(b). CONTRACTOR's liability for any injury or damage proximately caused by any "act of God" shall be limited to five percent (5%) of the Contract price pursuant to Government Code section 4150.

B. CONTRACTOR shall take, and require subcontractor to take, all necessary precautions for safety of workers on the work and shall comply with all applicable federal, state, local and other safety laws, standards, orders, rules, regulations, and building codes to prevent accidents or injury to persons on, about, or adjacent to premises where work is being performed and to provide a safe and healthful place of employment. In addition to meeting all requirements of OSHA, Cal-OSHA, state, and local codes, CONTRACTOR shall furnish, erect and properly maintain at all times, as directed by DISTRICT or required by conditions and progress of work, all necessary safety devices, safeguards, construction canopies, signs, audible devices for protection of the blind, safety rails, belts and nets, barriers, lights, and watchmen for protection of workers and the public and shall post danger signs warning against hazards created by such features in the course of construction. CONTRACTOR shall designate a responsible member of its organization on the work, whose duty shall be to post information regarding protection and obligations of workers and other notices required under occupational safety and health laws, to comply with reporting and other occupational safety requirements, and to protect the life, safety and health of workers. Name and position of person so designated shall be reported to DISTRICT by CONTRACTOR. CONTRACTOR shall correct any violations of safety laws, rules, orders, standards, or regulations. Upon the issuance of a citation or notice of violation by the Division of Occupational Safety and Health, such violation shall be corrected promptly.

C. In an emergency affecting safety of life, of work, or of adjoining property, CONTRACTOR, without special instruction or authorization from DISTRICT, is hereby permitted to act, at its discretion, to prevent such threatened loss or injury; and CONTRACTOR shall so act if so authorized or instructed by Architect or DISTRICT. DISTRICT will not hold CONTRACTOR liable for damages proximately caused by CONTRACTOR's actions if such actions were reasonably

necessary to prevent loss of life or injury to person or damage to work or adjoining property. Any compensation claimed by CONTRACTOR on account of emergency work shall be determined by agreement.

D. CONTRACTOR shall provide such heat, cooling, covering, and enclosures as are necessary to protect all work, materials, equipment, appliances, and tools against damage by weather conditions.

E. CONTRACTOR shall take adequate precautions to protect existing roads, sidewalks, curbs, pavements, utilities, adjoining property and structures (including, without limitation, protection from settlement or loss of lateral support), and to avoid damage thereto, and repair any damage thereto caused by construction operations. All permits, licenses, or inspection fees required for such repair work shall be obtained and paid for by CONTRACTOR.

F. CONTRACTOR shall (unless waived by the DISTRICT in writing):

- (1) When performing new construction on existing sites, become informed and take into specific account the maturity of the students on the site; and perform work which may interfere with school routine before or after school hours, enclose working area with a substantial barricade, and arrange work to cause a minimum amount of inconvenience and danger to students and faculty in their regular school activities. The CONTRACTOR shall comply with specifications and directives of the DISTRICT regarding the timing of certain construction activities in order to avoid unnecessary interference with school functioning.
- (2) Provide substantial barricades around any shrubs or trees indicated to be preserved.
- (3) Deliver materials to building area over route designated by Architect of District.
- (4) Take preventive measures to eliminate objectionable dust.
- (5) Confine apparatus, the storage of materials, and the operations of workers to limits indicated by law, ordinances, permits or directions of District and shall not interfere with the work or unreasonably encumber premises or overload any structure with materials; and enforce all instructions of DISTRICT regarding signs, advertising, fires, and smoking and require that all workers comply with all regulations while on construction site.
- (6) Take care to prevent disturbing or covering any survey markers, monuments, or other devices marking property boundaries or corners. If such markers are disturbed by accident, they shall be replaced by an approved land surveyor or civil engineer and all maps and records required shall be filed with county and local authorities, at no cost to the DISTRICT. All filing and plan check fees shall be paid by CONTRACTOR.

Article 34. NON-DISCRIMINATION

In the performance of the terms of this Contract, CONTRACTOR agrees that it will not engage in nor permit such subcontractor as it may employ to engage in unlawful discrimination in employment of persons because of the race, religious creed, color, national origin, ancestry, physical handicap, medical condition, marital status, or sex of such persons.

Article 35. CONTRACTOR CLAIMS

If CONTRACTOR shall claim compensation for any damage sustained by reason of the acts of DISTRICT or its agents, CONTRACTOR shall, within five (5) days after sustaining of such damage, make to District a written statement of the damage sustained. On or before the fifteenth (15th) day of the month succeeding that in which such damage shall have been sustained CONTRACTOR shall file with DISTRICT an itemized statement of the details and amount of such damage, and unless such statement shall be made as thus required, CONTRACTOR's claims for compensation shall be forfeited and invalidated and it shall not be entitled to consideration for payment on account of any such damage.

Article 36. DISPUTES - DISTRICT'S DECISIONS

A. District shall within a reasonable time, make decisions on all claims of DISTRICT or CONTRACTOR and on all other matters relating to the execution and progress of the work. The decisions of District shall not be binding, but shall be advisory only.

B. In the event of a dispute between the parties as to performance of the work, the interpretation of this Contract, or payment or nonpayment for work performed or not performed, the parties shall attempt to resolve the dispute. Pending resolution of the dispute, CONTRACTOR agrees it will neither rescind the Contract nor stop the progress of the work. If determination by the court of the State of California, in the applicable County, having competent jurisdiction of the dispute, is required, such action will occur after the Project has been completed, and not before.

Article 37. COMPLETION

The work may only be accepted as complete by action of the Governing Board.

Article 38. ADJUSTMENTS TO CONTRACT PRICE

A. If CONTRACTOR defaults or neglects to carry out the work in accordance with the contract documents or fails to perform any provision thereof, DISTRICT may, after ten (10) days written notice to CONTRACTOR and without prejudice to any other remedy it may have, make good such deficiencies.

B. DISTRICT shall adjust the total Contract price by reducing the amount thereof by the cost of making good such deficiencies. If DISTRICT deems it inexpedient to correct work injured or not done in accordance with Contract provisions, an equitable reduction in Contract price shall be made therefore.

Article 39. CORRECTION OF WORK

A. Should it be considered necessary or advisable by the Owner at any time before final acceptance of the entire work to make an examination of work already completed by removing or tearing out the same, the CONTRACTOR shall on request promptly furnish all necessary facilities, labor and materials. If such work is found to be defective in any respect due to fault of the CONTRACTOR or his subcontractor, he shall defray all expenses of such examinations and of satisfactory reconstruction. If, however, such work is found to meet the requirements of the Contract, the additional cost of labor and material necessarily involved in the examination and replacement shall be allowed the CONTRACTOR.

B. CONTRACTOR shall promptly remove from premises all work identified by DISTRICT as failing to conform to Contract, whether incorporated or not. CONTRACTOR shall promptly replace and re-execute its own work to comply with entrant documents without additional expense to DISTRICT and shall bear the expense of making good all work of other CONTRACTORS destroyed or damaged by such removal or replacement.

C. If CONTRACTOR does not remove such work within a reasonable time, fixed by written notice, DISTRICT may remove it and may store the material at CONTRACTOR's expense. If CONTRACTOR does not pay expenses of such removal within ten (10) days time thereafter, DISTRICT may, upon ten (10) days written notice, sell such materials at auction or at private sale and shall account for net proceeds thereof, after deducting all costs and expenses that should have been borne by CONTRACTOR.

Article 40. EXTENSION OF TIME - LIQUIDATED DAMAGES

A. THE CONTRACTOR AND DISTRICT HEREBY AGREE THAT THE EXACT AMOUNT OF DAMAGES FOR FAILURE TO COMPLETE THE WORK WITHIN THE TIME SPECIFIED IS EXTREMELY DIFFICULT OR IMPOSSIBLE TO DETERMINE. It is expressly understood that time is of the essence and that the Contractor must complete the Project within the time specified in the Agreement. CONTRACTOR shall be assessed the sum of Five Hundred Dollars (\$500.00) per day as liquidated damages for each and every day the work required under this contract remains unfinished past the time for completion, as set forth in the Agreement, and any extensions of time granted by the DISTRICT to the CONTRACTOR under the terms of the contract documents and pursuant to Section 53069.85 of the Government Code. For purposes of this article, the work shall be considered "complete" in accordance with the provisions of Article 60, Completion,

except that the work may be considered complete without formal acceptance by the Governing Board so long as the board, at its next regularly scheduled meeting, accepts the work.

B. CONTRACTOR shall not be charged for liquidated damages, as set forth above, because of any delays in completion of work which are not the fault or negligence of CONTRACTOR, including but not restricted to: acts of God, acts of public enemy, acts of Government, fires, floods, epidemics and quarantine restrictions. CONTRACTOR shall, within ten (10) calendar days of beginning of any such delay (unless DISTRICT grants in writing a further period of time to file such notice prior to date of final settlement of the Contract), notify DISTRICT in writing of causes of delay; thereupon DISTRICT shall ascertain the facts and extent of delay and grant extension of time for completing work when, in its judgment, the findings of fact justify such an extension. The DISTRICT's finding of fact thereon shall be final and conclusive on the parties hereto. Extensions of time shall apply only to that portion of work affected by delay, and shall not apply to other portions of work not so affected.

Article 41. PAYMENTS

A. Payments will be made per District Site. As each District Site is completed, contractor shall invoice an amount equal to ninety-five percent (95%) of the Contract total for that site to the DISTRICT'S Business Office. The invoice shall be paid after the DISTRICT'S Maintenance Supervisor approves the invoice. Work completed as estimated shall be an estimate only and no inaccuracy or error in said estimate shall operate to release CONTRACTOR or surety from any damages arising from such work or from enforcing each and every provision of this Contract, and DISTRICT shall have the right subsequently to correct any error made in any estimate for payment. CONTRACTOR shall not be entitled to have any payment estimates processed or be entitled to have any payment for work performed so long as any lawful or proper direction concerning work, or any portion thereof, given by DISTRICT shall remain uncompleted with.

B. Before payment is made hereunder, the DISTRICT will review the request for progress payment with DISTRICT and Inspector for verification that the work for which payment is requested has been performed in accordance with the Terms of the Contract.

C. Maintenance Supervisor shall sign the request for payment as verification that the work has been performed. It is understood more over, that signature of the Maintenance Supervisor shall not be conclusive upon DISTRICT, but merely advisory.

D. Prior to final payment, CONTRACTOR and each SUBCONTRACTOR shall certify that the Project does not contain any asbestos containing materials.

E. After completion of the WORK, CONTRACTOR shall make a demand for final payment. The demand for final payment shall identify all disputed and undisputed amounts due under the CONTRACT and, all claims for compensation under or arising out of this CONTRACT. The CONTRACTOR's negotiation of the payment of the final amount shall constitute a waiver of all amounts due under the CONTRACT and all claims against DISTRICT under or arising out of this CONTRACT except those identified by CONTRACTOR in writing, and unsettled before CONTRACTOR's negotiation of final payment. The final payment, if unencumbered, shall be made thirty-five (35) calendar days after recordation of the Notice of Completion by the County Registrar. Acceptance will be made only by ACTION OF THE GOVERNING BOARD.

F. No payment by DISTRICT hereunder shall be interpreted so as to imply that DISTRICT has inspected, approved, or accepted any part of the WORK.

Article 42. PAYMENTS WITHHELD

A. In addition to amount which DISTRICT may retain under Article entitled "COMPLETION" and Article entitled "PAYMENTS," DISTRICT may withhold a sufficient amount or amounts of any payment or payments otherwise due to CONTRACTOR, as in its judgment may be necessary to cover:

- (1) Payments which may be past due and payable for just claims against CONTRACTOR or any subcontractors, or against and about the performance of work on the Project under this Contract, including, without limitation, payments made pursuant to the article entitled "PAYMENTS BY CONTRACTOR";
- (2) The cost of defective work that CONTRACTOR has not remedied;

- (3) Liquidated damages assessed against CONTRACTOR;
- (4) Penalties for violation of labor laws;
- (5) The cost of materials ordered by the DISTRICT pursuant to the Article entitled "MATERIALS";
- (6) The cost of completion of this Contract if there exists a reasonable doubt that this Contract can be completed for the balance then unpaid to CONTRACTOR;
- (7) Site clean-up as provided in Article entitled "CLEANING UP."
- (8) Amount necessary to satisfy any and all liens against DISTRICT. CONTRACTOR shall provide release of all liens prior to final payment.
- (9) Damages to another CONTRACTOR.
- (10) Payments to indemnify, defend, or hold harmless the DISTRICT.
- (11) Any payments due to the DISTRICT including but not limited to payments for failed tests, utilities or imperfections.

B. If the CONTRACTOR, at its own expense, removes the reason for withholding, then payment shall be made for amount withheld.

C. DISTRICT may apply such withheld amount or amounts to payment of such claims or obligations at its discretion. In so doing, DISTRICT shall make such payments on behalf of CONTRACTOR. If any payment is so made by DISTRICT, then such amount shall be considered as a payment made under Contract by DISTRICT to CONTRACTOR and DISTRICT shall not be liable to CONTRACTOR for such payments made in good faith. Such payments may be made without prior judicial determination of claim or obligation. DISTRICT will render CONTRACTOR an accounting of such funds disbursed on behalf of CONTRACTOR.

D. As an alternative to payment of such claims or obligations, DISTRICT, in its sole discretion, may reduce the total Contract price as provided in the Article entitled "ADJUSTMENTS TO CONTRACT PRICE."

E. Payment by the DISTRICT shall be without prejudice to any other action by the DISTRICT to recover damages.

Article 43. EXCISE TAXES

If under Federal Excise Tax Law any transaction hereunder constitutes a sale on which a Federal Excise Tax is imposed and the sale is exempt from such Federal Excise Tax because it is a sale to a State or Local Government for its exclusive use, DISTRICT, upon request, will execute documents necessary to show (1) that DISTRICT is a political subdivision of the State for the purposes of such exemption and (2) that the sale is for the exclusive use of DISTRICT. No Federal Excise Tax for such materials shall be included in any bid price.

Article 44. TAXES

Bid price is to include any and all applicable sales taxes or other taxes that may be due in accordance with Section 7051 of the Revenue and Taxation Code; Regulation 1521 of the State Board of Equalization or any other tax codes that may be applicable.

Article 45. NO ASSIGNMENT

CONTRACTOR shall not assign this Contract or any part thereof.

Article 46. NOTICE AND SERVICE THEREOF

- A. Any notice from one party to the other or otherwise under Contract shall be in writing and shall be dated and signed by party giving such notice or by a duly authorized representative of such party. Any such notice shall not be effective for any purpose whatsoever unless served in one of the following manners:
- B. If notice is given to DISTRICT, by personal delivery thereof to DISTRICT or by depositing same in United States mail, enclosed in a sealed envelope addressed to DISTRICT, and sent by registered or certified mail with postage prepaid;
- C. If notice is given to CONTRACTOR by personal delivery thereof to said CONTRACTOR or to CONTRACTOR's superintendent at site of Project, or by depositing same in United States mail, enclosed in a sealed envelope addressed to said CONTRACTOR at its regular place of business or at such address as may have been established for the conduct of work under this Contract, and sent by registered or certified mail with postage prepaid;
- D. If notice is given to surety or other person by personal delivery to such surety or other person or by depositing same in United States mail, enclosed in a sealed envelope, addressed to such surety or person at the address of such surety or person last communicated by surety or other person to party giving notice, and sent by registered or certified mail with postage prepaid.

Article 47. NO WAIVER

The failure of DISTRICT in any one or more instances to insist upon strict performance of any of the terms of this Contract or to exercise any option herein conferred shall not be construed as a waiver or relinquishment to any extent of the right to assert or rely upon any such terms or option on any future occasion.

Article 48. HAZARDOUS MATERIALS

In the event the CONTRACTOR encounters on the site material reasonably believed to be asbestos or polychlorinated biphenyl (PCB) which has not been rendered harmless, the CONTRACTOR shall immediately stop work in the area affected

and report the condition to the DISTRICT in writing. The work in the affected area shall not thereafter be resumed except by written agreement of the DISTRICT and CONTRACTOR if in fact the material is asbestos or polychlorinated biphenyl (PCB) and has not been rendered harmless. The work in the affected area shall be resumed in the absence of asbestos or polychlorinated biphenyl (PCB), or when it has been rendered harmless, by written agreement of the DISTRICT and CONTRACTOR, or in accordance with final determination by the District.

Article 49. OWNER'S RIGHT TO CARRY OUT THE WORK.

If CONTRACTOR defaults or neglects to carry out the work in accordance with the contract documents or fails to perform any provision of this Contract, the owner may, after ten (10) calendar days' written notice to CONTRACTOR and without prejudice to any other remedy he may have, made good such deficiencies. In such case an appropriate Change Order shall be issued deducting from the payments then or thereafter due CONTRACTOR the cost of correcting such deficiencies, including the cost of the Architect's additional service made necessary by such default, neglect or failure. If the payments then or thereafter due CONTRACTOR are not sufficient to cover such amount, then CONTRACTOR shall pay the difference to the Owner within ten (10) calendar days.

Article 50. INDEMNIFICATION

A. The CONTRACTOR shall indemnify and hold harmless the DISTRICT, the DISTRICT's officers, agents, and employees, consultants and employees from every claim or demand made, and every liability, loss, damages, or expense, of any nature whatsoever, which may be incurred by reason of:

- (1) Liability for (a) death or bodily injury to persons; (b) damage or injury to, loss (including theft), or loss of use of, any property; (c) any failure or alleged failure to comply with any provision of law or the Contract

Documents; or (d) any other loss, damage or expense, sustained by any person, firm or corporation or in connection with the Work called for in this Agreement or the Contract Documents, except for liability resulting from the sole or active negligence, or the willful misconduct of the DISTRICT.

- (2) Any bodily injury to or death of persons or damage to property caused by any act, omission or breach of CONTRACTOR or any person, firm or corporation employed by CONTRACTOR, either directly or by independent contract, including all damages or injury to, loss (including theft), or loss of use of, any property, sustained by any person, firm or corporation, including DISTRICT, arising out of or in any way connected with Work covered by this Agreement or the Contract Documents, whether said injury or damage occurs either on or off DISTRICT property, but not for any loss, injury, death or damages caused by the sole or active negligence or willful misconduct of the DISTRICT.
- (3) Any dispute between CONTRACTOR and CONTRACTOR's subcontractors/supplies/sureties, including, but not limited to, any stop notice actions.

B. CONTRACTOR, at CONTRACTOR's own expense, cost, and risk, shall defend any and all claims, actions, suits, or other proceedings that may be brought or instituted against the DISTRICT, its officers, agents or employees, on any such claim or liability, and shall pay or satisfy any judgement that may be rendered against the DISTRICT, its officers, agents or employees in any action, suit or other proceedings as a result thereof.

Article 51. NON-UTILIZATION OF ASBESTOS MATERIAL

NO ASBESTOS OR ASBESTOS-CONTAINING PRODUCTS SHALL BE USED IN THIS CONSTRUCTION OR IN ANY TOOLS, DEVICES, CLOTHING, OR EQUIPMENT USED TO EFFECT THIS CONSTRUCTION. Asbestos and/or asbestos-containing products shall be defined as all items containing, but not limited to, chrysolite, amosite, anthophyllite, tremolite, and actinolite. Any or all material containing greater than one-tenth of one percent (1%) asbestos shall be defined as asbestos-containing material. All work or materials found to contain asbestos or work or material installed with asbestos-containing equipment will be immediately rejected and this work will be removed at no additional cost to the DISTRICT.

Article 52. LIEN RELEASES

CONTRACTOR shall, at its own cost, defend, indemnify and hold harmless the DISTRICT, its officers, agents, employees, assigns, and successors in interest, from and against any and all liability, damages, losses, claims, demands, actions, causes of action, and costs including attorney's fees and expenses, or any of them, arising from or attributable to a lien or stop notice filed and/or severed in connection with the work.

**West Side Parking Lots & Playgrounds Seal & Stripe
VICTOR ELEMENTARY SCHOOL DISTRICT**

TABLE OF CONTENTS TO THE SPECIAL CONDITIONS

ARTICLE	PAGE
SC1 DEFINITION OF "DEVELOPER"	2
SC2 NO EXTENDED TIME TO TRADE CONTRACTOR'S SHORTENED SCHEDULE	2
SC3 CONSTRUCTION ACCESS AND STAGING AREA	2
SC4 LIMITED ACCESS DURING SUMMER SCHOOL	3
SC5 WORK HOURS AND SCHOOL TESTING CONFLICT	3
SC6 NO SMOKING, APPROPRIATE ATTIRE, NO PROFANITY	3
SC7 INTENT OF DRAWINGS	4
SC8 DAILY REPORTS	4
SC9 SUPPLEMENTAL GENERAL CONDITIONS ITEMS	4
SC10 SAFETY PRECAUTIONS & PROGRAM	4
SC11 INDEMNITY	6
SC12 ALLOWANCES	6
SC13 REQUIRED MEETINGS AND SITE INVESTIGATION	6
SC14 NORMAL SEASONAL RAIN	7
SC15 IDENTIFICATION BADGES	7
SC16 PERMITS	7
SC17 PROJECT SCHEDULE	8
SC18 CM SPECIFICATIONS	8

SPECIAL CONDITIONS OF THE CONTRACT

SC Article 1. DEFINITION OF "DEVELOPER."

For purposes of this project, wherever the word "Developer" is written (specifically on Contract Documents that must be submitted for approval to City and County agencies, and to utility companies), it shall be construed to mean "CONTRACTOR," unless specifically stated in each instance of use of the word "Developer" to be a party other than "CONTRACTOR."

SC Article 2. NO EXTENDED TIME TO TRADE CONTRACTOR'S SHORTENED SCHEDULE.

Contract time shall be as set forth in the construction documents. When the CONTRACTOR submits Construction Schedule shorter than contract time allowed, it shall not be construed that DISTRICT implicitly or explicitly accepts or approves such schedule as an amendment of contract time. Extensions of contract time, and any costs attendant thereto, shall apply only and exclusively to extensions beyond contract time as set forth in the Agreement. In no way shall an extension of contract time, whether for rain delay or other valid reason as set forth in the Contract Documents, be construed as applying to the CONTRACTOR'S proposed or accepted Construction Schedule.

CONTRACTOR agrees that a Construction Schedule shorter than contract time is solely for the CONTRACTOR'S convenience and benefit and no benefit accrues to the DISTRICT, therefore, all risks and costs of delays to such schedule shorter than contract time (and up to contract time) shall be borne by CONTRACTOR.

SC Article 3. CONSTRUCTION ACCESS AND STAGING AREA

Except during the summer break, construction access to the Project areas shall be ONLY via access designated by the District. NO construction traffic shall be allowed across the school proper without expressed permission of the District. During school breaks, other means of access may be available, but only with the expressed permission of the School District.

An area will be indicated by the District as a "Staging Area" and shall be the only on-site area allowed for storage, staging, parking of construction vehicles, and offices. At all times, construction activity shall remain completely segregated from normal school activity. Such items of work that require access to other parts of the campus (such as utility line work) shall be coordinated **a minimum of one week in advance** with the DISTRICT so that school function suffers the minimum of impact. Decisions of the DISTRICT as to times of access shall be final and binding.

SC Article 4. LIMITED ACCESS DURING SUMMER SCHOOL

As work will take place during district's normally scheduled summer school session, the hours of work will be stipulated to be 6 am to 3 pm, as a regular scheduled shift time. Access will not be available to the school sites before this start time. Access at alternate times to this schedule can only be arranged and coordinated with the district's Construction Manager. Summer school schedule shall be finalized prior to construction and contractor shall modify construction schedule to ensure work is not ongoing during summer school schedule.

**West Side Parking Lots & Playgrounds Seal & Stripe
VICTOR ELEMENTARY SCHOOL DISTRICT**

CONTRACTOR shall schedule all construction activities, and require all Subcontractor CONTRACTORS, suppliers, and employees to likewise schedule their activities in such a manner that no trucks, construction vehicles, delivery vehicles, or construction personnel's personal vehicles in any way impact the normal daily operating routine of the school. CONTRACTOR and his construction superintendent shall attend a formal pre-construction conference, scheduled by the School District, for the specific purpose of clarifying all access issues.

SC Article 5. SCHOOL TESTING HOURS

As work will take place during summer school year, there shall be no construction noise allowed during school hours on formally scheduled all-school testing dates. Exact hours of each moratorium shall be provided to the CONTRACTOR with adequate time to adjust work schedule after award of contract. CONTRACTOR shall allow for any effect on construction costs and schedules in their bid. No extras will be allowed due to the noise moratoriums. CONTRACTOR may submit a noise control plan for construction activity during these times, which may be approved at the sole discretion of the DISTRICT.

SC Article 6. NO SMOKING, APPROPRIATE ATTIRE, NO PROFANITY

Whenever CONTRACTOR's, Subcontractors', or Suppliers' personnel are within School DISTRICT property, they shall observe the smoking prohibition. Any personnel refusing to comply shall be removed by the CONTRACTOR from the Project at the request of the School DISTRICT. This smoking prohibition shall extend to all forms of vaping.

As construction on most of these projects may proceed within sight and hearing of children, CONTRACTOR's, Subcontractors', and Suppliers' personnel are required to wear appropriate attire at all times (hard hats, long pants, shirts with sleeves, and work boots are required), as determined by the School DISTRICT, and refrain from the use of profanity or inappropriate language as determined by the School DISTRICT. CONTRACTOR shall enforce strict discipline and good order among employees. Any personnel refusing to comply shall be removed by the CONTRACTOR from the Project at the request of the Construction Manager.

SC Article 7. INTENT OF DRAWINGS

Scope of work as indicated in the contract drawings will be determined in context of all the contract drawings. Minor irregularities will be interpreted by the general intent indicated in the contract documents as a whole. If a reasonable interpretation is not attainable, the CONTRACTOR is to bid the most stringent or highest degree of work indicated.

Promptly submit written notice to the Construction Manager of any observed variance in Contract Documents from legal requirements. Any modifications to Contract Documents will be issued by the Owner, Architect or Construction Manager.

Field Work Directives: Erickson-Hall Construction Co. may issue Field Work Directives to CONTRACTOR. CONTRACTOR is to proceed immediately with the work as directed. Field Work Directives are not approvals for change orders or payment. If CONTRACTOR is in disagreement that the work directed is a part of the CONTRACTOR's contracted scope of work, the CONTRACTOR is to document the work incurred by providing daily documentation to EHCC's superintendent or the onsite Project Inspector for verification of labor, material and or equipment. Failure to document the work on a daily basis is grounds for invalidating the work taken place on that day.

**West Side Parking Lots & Playgrounds Seal & Stripe
VICTOR ELEMENTARY SCHOOL DISTRICT**

SC Article 8. DAILY REPORTS

Submission of Daily Report: CONTRACTOR shall be required to submit Daily Work Reports only to the Construction Manager on the forms provided after award of contract. Daily Report forms will be used by the Construction Manager to track work progress and issues, and to verify certified payroll reports. Each CONTRACTOR is responsible for ensuring their Subcontractor(s) comply with the daily report requirement. Failure to submit Daily Reports, will be grounds for an immediate damage assessment of \$75 per daily incident. Daily Reports are to be turned in by 10:00 A.M. each day for the previous day's work.

SC Article 9. SUPPLEMENTAL GENERAL CONDITIONS ITEMS

Revision to General Conditions Article 15 – Payment Bond

Add: Number of executed, notarized original performance and payment bonds needed, is three (3).

SC Article 10. SAFETY PRECAUTIONS & PROGRAM

The CONTRACTOR shall strictly comply with all applicable laws, ordinances, rules, regulations, and orders issued by a public authority, whether federal, local or otherwise, state industrial safety and health statutes applicable to occupational health and safety, and any and all safety, security and environmental protection measures or standard required or prescribed by the Owner and/or Construction Manager. Without limiting the foregoing, CONTRACTOR shall comply with the requirements of the Occupational Safety and Health Act of 1970 (United States), as amended (“OSHA”), and any rules, regulations (including 29 CFR parts 1910 and 1926), procedures and practices promulgated thereunder (collectively, the “OSHA regulations”). CONTRACTOR shall ensure that its Subcontractors, material suppliers, and any person directly or indirectly employed by them, comply with the provisions of this section 11.13 by inserting the requirements hereof in any subcontract or purchase order.

The CONTRACTOR will possess and implement a comprehensive health and safety program for their workers covering all aspects of its scope of Work and activities associated with the Subcontract. A Subcontractor’s health and safety program is considered supplementary to the CONTRACTOR’s PSSP. The CONTRACTOR is to supply a copy of such health and safety program to the CONTRACTOR within ten (10) days of the date of this contract.

CONTRACTOR shall use every device, care and precaution which is practicable to use for the protection and safety of life and limb, and for the identification and elimination of hazards to the health and safety of workers under its control in the performance of the Work, all without regard to the additional cost of suitable material for safety appliances and devices. Without limiting the foregoing, CONTRACTOR shall provide protection to prevent damage, injury or loss to (i) its employees whether on or off the Project and all other persons who may be affected thereby; (ii) all materials and equipment to be incorporated into its Work, whether in storage on or off the Project or under the care, custody or control of CONTRACTOR or any of its lower tier Subcontractors or suppliers; and (iii) other property at the Project or adjacent thereto, including trees, shrubs, lawns, walkways, pavements, roadways, structures and utilities not designated for removal, relocation or replacement by CONTRACTOR in accordance with the Contract Documents.

The CONTRACTOR will assign a qualified person to the Project to supervise and manage all aspects of the CONTRACTOR’s Work in a safe and healthy manner. The CONTRACTOR shall take adequate measures to identify and eliminate hazards that can affect the health and safety of any worker or member of the general public. The CONTRACTOR shall immediately comply with any orders imposed by local

**West Side Parking Lots & Playgrounds Seal & Stripe
VICTOR ELEMENTARY SCHOOL DISTRICT**

government agencies or issued to the CONTRACTOR as a result of Construction Manager -conducted site inspections. CONTRACTOR shall also give prompt written notice to Construction Manager of any accident involving personal injury requiring a physician's care, any property damage exceeding Five Hundred Dollars (\$500.00) in value, or any failure that could have resulted in serious personal injury, whether or not such an injury was sustained.

If, during the course of the contract, the Construction Manager discovers situations of non-compliance with the CONTRACTOR's health and safety program, the CONTRACTOR's PSSP or any federal, state, local or other government requirements, issues of non-compliance will be communicated to the CONTRACTOR's site representative verbally and followed up in writing. Construction Manager has authority in an emergency to stop the progress of the Work whenever, in its opinion, such stoppage may be necessary to ensure the safety of the life, or protection against other loss, on any part of the Work or the Project or neighboring property.

It is expressly agreed between CONTRACTOR and Construction Manager that for all hazardous conditions created or arising within the scope of CONTRACTOR's Work, that CONTRACTOR is the "employer" within the meaning of any applicable state imposed OSHA Regulation and that further, for any hazardous conditions referenced herein, CONTRACTOR is the "creating, exposing, correcting and/or controlling employer" within the meaning of any applicable state imposed OSHA Regulation.

If after due notice CONTRACTOR or any of its Subcontractors or suppliers, or any person directly or indirectly employed by them, fails to comply with the provisions of this paragraph 11.13, then Construction Manager may take whatever measures it deems necessary to ensure compliance and to maintain the requisite health and safety standards on the Project, and CONTRACTOR shall immediately reimburse Construction Manager for the full cost thereof. Without limiting the foregoing, the CONTRACTOR shall pay for all reasonable costs and expenses, including any penalties and fines resulting from breaches to applicable laws, ordinances, rules, regulations, and orders issued by a public authority, whether federal, state, local or otherwise, OSHA, and any and all safety, security and environmental protection measures or standards required or prescribed by the Owner and/or Construction Manager that the CONTRACTOR may incur as a result of the non-compliance with the provisions of this section 11.13 by the CONTRACTOR, its Subcontractors, material suppliers or any person directly or indirectly employed by them. Failure to take corrective action once advised, or continued non-compliance of health and safety requirements, is in violation of the contract and could lead to termination of the contract.(h) CONTRACTOR shall, at its own expense: (i) provide suitably qualified and certified personnel to perform any rigging required for the performance of the Work; (ii) provide flag persons and traffic control as required to protect and ensure the safety of the general public during CONTRACTOR's construction activities; (iii) procure any CONTRACTOR-specific road closures required for the performance of the Work; (iv) provide any task lighting required to perform the Work; and (e) if the contract price is: (x) equal to or less than \$1,000,000, participate in a daily clean-up of the common areas of the Project; or (y) greater than \$1,000,000, provide full-time clean-up persons as required to remove waste from the Project continuously throughout the course of normal working hours.

CONTRACTOR shall ensure that all persons directly or indirectly employed by CONTRACTOR or its Subcontractors or suppliers shall wear, at a minimum, high-visibility vests, work boots and hard hats while working on the Project.

SC Article 11. INDEMNITY

The CONTRACTOR shall defend, indemnify and hold the Owner, Architect, Architect's Consultants and Construction Manager harmless from any and all liability, real or alleged in connection with the

**West Side Parking Lots & Playgrounds Seal & Stripe
VICTOR ELEMENTARY SCHOOL DISTRICT**

performance of work on this Project.

The CONTRACTOR agrees to assume sole and complete responsibility for own job site conditions during the course of construction of this Project, including the safety and all persons and property. The requirement shall apply continuously and shall not be limited to normal working hours.

SC Article 12. ALLOWANCES

Contractor shall include allowance amount of \$25,000.00, as already noted on the bid form, for scope of work as undefined, with markup included as part of the base bid. No markup will be allowed for District use of allowance. Unused allowance amount will be returned to the District via change management process.

SC Article 13. REQUIRED MEETING AND SITE INVESTIGATIONS

As noted on the project schedule, there are several required mandatory meetings in advance of building construction and these will include but not be limited to the following:

- Post Bid Tender Meeting with Construction Manager
- CONTRACTOR Site Investigation with their project superintendent as shown in the Project Schedule. CONTRACTOR is required to investigate and document all existing conditions to ensure all contract work can be completed.
- Pre-Construction Meeting with Construction Manager, District and Inspector.
- Pre-Mobilizations Meetings, bi-weekly from NTP until such time as all submittals have been approved and material procurements has been guaranteed.
- Initial Schedule meeting with contractor.
- CONTRACTOR Progress Meetings, weekly onsite Construction Manager and Inspector.
- Daily onsite Foreman huddle in the jobsite trailer.

Requirement to attend all meetings, as scheduled and coordinated is mandatory and will not be waived. Failure to attend any meeting, will be grounds for an immediate damage assessment of \$100 per incident.

SC Article 14. NORMAL SEASONAL RAIN

The following is a clarification and amplification of requirements set forth in the General Conditions: By entering into this Contract, the CONTRACTOR certifies that he is capable of completing the Work within the calendar time allotted by the Agreement. It is to be expected that the Work will be affected by periodic and normal rain. Normal seasonal rainfall and its effect on construction shall be taken into account by the CONTRACTOR when formulating his bid and incorporating the project schedule. **NO EXTENSIONS OF CONTRACT TIME WILL BE GRANTED DUE TO NORMAL SEASONAL RAIN-FALL** as set forth in the following historical records table for the appropriate months of Contract Time. Based on weather data available from San Bernardino County Flood Control, Data Collection Dept., the average number of days in which rainfall has been recorded over the last 39 years during the months applicable to the proposed construction period, shall be calculated from the table. By entering into this contract, CONTRACTOR agrees to build into his construction schedule the above amount of rainfall events and its effects on the Work.

For this project, and in accordance with the above noted data, TRADE CONTRACTOR is required to include 4 rain days in project schedule.

**West Side Parking Lots & Playgrounds Seal & Stripe
VICTOR ELEMENTARY SCHOOL DISTRICT**

Note that a recorded "rain event" as defined by San Bernardino County flood Control could be, for instance, a total of ¼ inch of rain on a Sunday, as well as 2 inches per hour during foundation trenching.

SC Article 15. IDENTIFICATION BADGES

As part of District policy and standard, all CONTRACTOR's, Subcontractor's', and trade workers shall be required to wear visible ID badges, identifying their company at a minimum, on their person at all times when on School District property. The company shall be responsible for ensuring all employees adhere to this requirement. Failure to keep and maintain badge on person, will be grounds for removal from site.

SC Article 16. PROJECT SCHEDULE

Construction Manager has prepared a preliminary schedule. CONTRACTOR shall still retain the obligation to prepare a more detailed schedule of their scope of work, still allowing for subsequent trades to meet their timelines, and overall milestones timelines. Failure to submit schedule will indicate approval by CONTRACTOR of CM schedule and no further request for time revisions will be granted. In accordance with the specification section dealing with same, each CONTRACTOR to affix their signature, in agreement, on hard copy plotted schedule that will remain posted in jobsite trailer as confirmation of understanding project requirements.

The project schedule is milestone in detail, summary in level, and does not identify each work activity required to complete the trade work. This schedule is incorporated into Contract Documents herein as attachment to these Special Conditions.

SC Article 17. CM SPECIFICATIONS AND BID PACKAGES

CM Specifications, 00 10 00-General Requirements, 00 46 00-Post Bid Interview, are incorporated into the Contract Documents as attachments to these Special Conditions.

END OF SPECIAL CONDITIONS

SECTION 00 10 00

GENERAL REQUIREMENTS – DIVISION 1

PART 1 GENERAL

- 1.1 Contractor is responsible for own assessment of security needs within and around site boundaries and to maintain sufficient security and safety measures to effectively prevent vandalism, vagrancy, theft, arson, and all other such negative impacts to own work. Any impacts to the progress of the work due to loss from inadequate security and safety measures, will be the responsibility of the Contractor.
- 1.2 Bid Package Contractor also to mean this Contractor.
- 1.3 The method of correspondence for Contractor shall be Procore. Contractor shall create a Procore, which is a web based program. A meeting to discuss the Procore process will be scheduled prior to submittal submission.
- 1.4 Contractor, by submitting a bid, is acknowledging that he/she has made a thorough inspection of this project site and that Contractor has made a detailed comparison between the existing conditions on the site and those indicated within the Contract Documents.
- 1.5 Provide all submittals including product data, shop drawings, samples, deferred submittals, schedules, and any other documentation required for approval required by the project documents and architect to assure long lead times do not affect the scheduled work. The Contractor shall provide a list of long lead material and equipment and expected lead times for scheduling purposes. In addition, all required architectural selections (i.e. colors, material, finish, texture, etc.) embedded in the submittal must be specifically tabbed and highlighted within the submittal and also noted on the transmittal page. In the event no option is chosen by the architect, the prime contractor shall submit an RFI for clarification.
- 1.6 A post-bid review will be required for the specified low bidder which will be conducted at the District Office. See Construction Manager Supplemental Specification Section 00 46 00 – Post Bid Interview. Low Bid Contractor shall bring to the meeting the questionnaire included in the Specification Section 00 46 00 filled out and ready to discuss. Please be prepared to sign project documents. This is a mandatory meeting for the low bidder. The meeting will take place the day after the bid or shortly thereafter.
- 1.7 This Contractor will have a foreman/superintendent attend and participate in mandatory weekly coordination meetings as scheduled by the Construction Manager. In these meetings, the foreman/superintendent will be prepared to discuss coordination and scheduling of their bid package work. Failure of Contractor's representative to attend scheduled weekly mandatory Progress Meetings will result in a \$100 backcharge to Contractor for each missed meeting unless specifically excused by the Construction Manager.
- 1.8 Contractor shall include in base bid cost of obtaining and paying for all governmental agencies, utility company permits, licenses and fees required in accordance with the contract documents for

- the performance of the work such as traffic control permits and haul route permits. All cost associated with the permits shall be the responsibility of this Contractor.
- 1.9 Contractors is required to ensure they have all permits associated with their scope of work including, but not limited to, OSHA's annual permit and any other permit necessary.
 - 1.10 Contractor shall provide adequate temporary sanitary facilities at each site.
 - 1.11 Contractor shall provide a detailed CPM project schedule and the work shall be scheduled within the timeline identified in the Special Conditions. Based on that CPM schedule, the Contractor shall be required to participate in the Pull Planning Scheduling as a means of activity scheduling in order to meet the project schedule.
 - 1.12 Contractor is responsible for environmental conditions for own work.
 - 1.13 Work hours shall comply with the City of Victorville's local ordinances including adherence to limited hours for noisy exterior work.
 - 1.14 Contractor will be required and responsible to coordinate with the City of Victorville for approved haul routes and pay for any associated fees.
 - 1.15 Contractor acknowledges that in the event closeout and warranty documentation required by the contract documents for own scope of work is not received prior to completion of the project, \$1,500 will be detained from Contractor's payment until all documentation is received.
 - 1.16 This Contractor will be responsible for the construction temporary water meter and meter fees as required by the Water District.
 - 1.17 Contractor will be required to provide the DVBE Good Faith certification with the bid documents required on bid day.
 - 1.18 Notify affected utility companies and District prior to starting utility work and comply with their requirements.
 - 1.19 Contractor shall comply all BMP's contained in the State Water Authority's Storm Water Permit that could be associated with the work.
 - 1.20 Contractor shall provide protection of areas of work either by caution tape, continual cone barricade or fencing. At locations where trench excavation is occurring, all trenches shall be protected overnight.
 - 1.21 Multiple move-ins may be required for the performance of this bid package. There is no predetermined number of move-ins required to meet contract schedule. Work shall be done in accordance with the project schedule and the requirements of the Construction Manager.
 - 1.22 Daily clean-up of all debris related to the Work of this Contractor is required. All debris generated by Contractor shall be legally removed daily and disposed of offsite by Contractor.
 - 1.23 On project buildings, temporary offices, storage containers, etc, promptly obscure and/or repair any vandalism and graffiti on own work on a daily basis.

- 1.24 This Contractor will provide Daily Work Reports on a daily basis delivered to Construction Manager no later than 9:00 a.m. for the previous day worked. Include all information of Work and workmen by vendors, equipment owner/operators, visitors and sub-contractors. Sub-Contractors Daily Work Report shall be attached to Contractor's daily work report.
- 1.25 All Certified Payrolls must be received prior to payment for each month billed including all subcontractors and tier subcontractors. No progress drawing payments will be approved without the previous month certified payroll records received.
- 1.26 The Contractor and their Subcontractors and tier Subcontractors will be required to submit a DAS 140, DAS 142, and Fringe Benefit Statement prior to start of any work on site. In the event these documents are not received, no work will shall be performed.
- 1.27 Work will be performed uninterrupted throughout the project duration, sometimes if necessary, at night. This Contractor will be available to perform Work for the duration of the project and will respond, and be on site, to perform the Work, within 24 hours if requested by the Construction Manager.
- 1.28 Contractor shall bid the most costly option in the event of conflict, duplicative assignments, or ambiguities in the contract documents unless clarified prior to bid.
- 1.29 Contractor shall protect all work related to this bid package from weather related damage. Contractor will replace all weather damaged work at their own cost for all labor, material, equipment and time.
- 1.30 Contractor shall coordinate with all School District representative and Utility Agencies as necessary to permit, schedule, and perform work related to this Contractor.
- 1.31 Contractor shall forward cost proposals no later than 4 days from requested timeframe. In the event cost proposals are not received within the allotted time frame, the Construction Manager will determine all additional costs and credits for the scope of work based on the most current RSMMeans pricing manual.
- 1.32 Completely furnish, properly install, and maintain all barricades, traffic control, warning lights, flagmen, steel track-out plates for construction entrance and exit to the project site; hauling and proper disposal permits including fees as may be required by the City of Victorville, CA, San Bernardino, and the Construction Manager as it pertains to the work of this bid package.
- 1.33 Provide all required layout as required for the work of this Bid Package Contractor
- 1.34 Provide all necessary protection to all existing and surrounding buildings, surfaces and finishes, utilities, underground utilities during installation of work. Any damage caused shall be repaired to the satisfaction of the Construction Manager, District and Architect of Record.
- 1.35 Contractor shall include products from listed manufacturers only. Substitutions will not be accepted in bids without having an approved substitution request approved by the architect and/or engineers of record. See the Project Manual, for additional instructions. All substitutions must be submitted with a complete substitution request form and appropriate credit to owner. No exceptions.

- 1.36 Contractor acknowledges that any deviation from the contract documents shall be documented through the RFI process. In the event the Contractor proceeds with installation of any deviation from the contract documents, the Contractor will be responsible for all re-work or correction if the deviation is unacceptable to the Owner, Construction Manager, or Design Team.
- 1.37 All excess spoils generated by this operation shall be removed and legally disposed of off-site on a daily basis.
- 1.38 Preserve, in operating condition, any active utilities transversing the site. Protect property / utilities scheduled to remain including, but is not limited to, locate and mark utility mains, manholes, catch basins, valve boxes, utility poles, guy wires, and other existing utilities encountered.
- 1.39 Include and pay all costs associated with additional testing and inspections due to failed tests for work in place by the bid package contractor.
- 1.40 Contractor agrees and acknowledges that certain design errors and omissions can and do occur in the project contract documents and that it has been the Contractor's duty and responsibility to fully and thoroughly review the contract documents for such type of errors and omissions as related to their scope of work. Whereas the Contractor has had adequate opportunity to bring these discrepancies to the attention of the Construction Manager and Architect and offer solutions. This Contractor agrees and acknowledges that any discrepancy that could have been discovered with reasonable due diligence shall be the sole responsibility of the Contractor to resolve at no additional cost to the District. Contractor, being a licensed professional, is responsible to know and understand code issues as related to their area of work and therefore be able to identify obvious design discrepancies as related to buildings codes and thereby accepts responsibility as listed above. However, the Contractor is not a licensed Engineer or Architect and thereby is not responsible for design discrepancies that would have been reasonably required the expertise of a licensed Engineer or Architect to discover during the pre-construction phase of work.

SECTION 00 46 00

POST BID INTERVIEW

1.01 SUMMARY

This Section requires each apparent low bidder to attend and participate in a POST BID INTERVIEW with the CONSTRUCTION MANAGER, prior to award of any contract by the DISTRICT. The POST BID INTERVIEW will be scheduled by the CONSTRUCTION MANAGER after the date of bid. The Conditions of the Contract and all other Sections of the Contract apply to this Section as fully as if repeated herein.

1.02 REQUIRED ATTENDANCE

- A. A duly authorized representative of the apparent low bidder is required to attend the POST BID INTERVIEW, in person.
- B. The apparent low bidder's authorized representative must have signatory authority on behalf of the apparent low bidder.
- C. Failure to attend the POST BID INTERVIEW will be considered just cause for the District to reject the Bid.

1.03 POST BID INTERVIEW PROCEDURE

- A. The CONSTRUCTION MANAGER AND DISTRICT will review the Bidder's Proposal with the attendees.
- B. The CONSTRUCTION MANAGER will review the following with the attendees, including but not limited to:
 - 1. Insurance
 - 2. Bonding
 - 3. Addenda
 - 4. Pre-Bid Clarifications
 - 5. Scope of Work
 - 7. Value Engineering
 - 8. The Contract Plans
 - 9. The Contract Specifications
 - 10. The Master Schedule
 - 11. Critical Materials
 - 12. General Contract Schedule Requirements
 - 13. Prevailing Wage Requirements
 - 14. Critical Dates Requirement
 - 15. Liquidated Damages
 - 16. Required Documentation for Contract Administration
 - 17. Contract Coordination Requirements

POST BID INTERVIEW

West Side Parking Lots & Playgrounds Seal & Stripe
Victor Elementary School District

18. DVBE Requirements

1.04 POST BID INTERVIEW DOCUMENTATION

The CONSTRUCTION MANAGER will document the POST BID INTERVIEW on the form attached to this Section. Both the Apparent Low Bidder and the CONSTRUCTION MANAGER are required to sign the POST BID INTERVIEW Documentation. Signatures will be witnessed at the time of signing. The POST BID INTERVIEW Documentation is a Contract Document, and all items recorded in the POST BID INTERVIEW Documentation are part of the Contract and shall be enforced accordingly. POST BID INTERVIEWS will be conducted at the CONSTRUCTION MANAGER'S office or DISTRICT'S OFFICES.

**SEE QUESTIONNAIRE STARTING
ON NEXT PAGE**

CONSTRUCTION MANAGER

Erickson-Hall Construction Co., Inc.
500 Corporate Drive
Escondido, CA 92029

PHONE: (760) 796-7700 FAX: (760) 796-7750

BIDDER: _____

Authorized Signer _____

Title of Authorized Signer _____

Email of Authorized Signer _____

DATE: _____ TIME: _____ PHONE # _____

I. INTRODUCTIONS: (SIGN IN BELOW)

A. Present _____	CONTRACTOR	_____	CONTRACTOR
	_____	_____	_____
	District Representative	District Representative	
	_____	_____	
	CONSTRUCTION MANAGER	CONSTRUCTION MANAGER	

II. PROPOSED CONTRACT:

A. Bid Category: _____

B. Proposed Contract Amount: \$ _____

III. PURPOSE OF INTERVIEW IS TO ASSURE:

- A. Contractor acknowledgment of a complete and accurate bid.
- B. Contractor submission of a fair and equitable bid.
- C. Fair comparisons of bid.
 - 1. Contractor will honor bid amount regardless of how bid compares to the second low bidder.

POST BID INTERVIEW

West Side Parking Lots & Playgrounds Seal & Stripe
Victor Elementary School District

IV. CONTRACTUAL REQUIREMENTS:

- | | | | |
|----|---|-----|----|
| A. | Do you understand you are a prime contractor? | Yes | No |
| B. | Can you meet all specified insurance requirements?
(Reference General Conditions and Special Conditions Article E of the Project Manual) | Yes | No |
| C. | You are required to obtain a Performance, and a Labor and Material Bond for 100% of the Contract price | | |
| 1. | Is this acceptable? | Yes | No |
| 2. | Will you provide bonds as stipulated? | Yes | No |
| 3. | Is the cost of the bond in your base bid? | Yes | No |
| 4. | Is your insurance company California licensed? | Yes | No |
| D. | Acknowledged Receipt of Pre-Bid Clarification Questions | Yes | No |
| E. | Are all costs for addenda items included in your proposal (if applicable)? | Yes | No |

V. SCOPE OF WORK:

- | | | | |
|----|---|-----|----|
| A. | You have a complete understanding of the Scope of Work under the proposed Agreement | Yes | No |
| | To include but not be limited to: | | |
| 1. | Coordination of work with all parties. | Yes | No |
| 2. | Secure and pay for all fees and permits as applicable to the work of this Bid Category. | Yes | No |
| 3. | Provide security for the work, fences and barricades. | Yes | No |
| 4. | Understanding of project working hours. | Yes | No |
| 5. | Acknowledge potential to perform work at nights or on weekends to accommodate schedule. | Yes | No |
| 6. | Includes all/any required weather protection. | Yes | No |

POST BID INTERVIEW

- | | | | |
|-----|---|-----|----|
| 7. | Temporary facilities as required for the work of this Bid Category. | Yes | No |
| 8. | Temporary sanitary facilities for the duration of work. | Yes | No |
| 9. | Site logistics plan and coordination with campus. | Yes | No |
| 10. | Substitution “or equal” for consideration were submitted at closing of bid. | Yes | No |
| 11. | Temporary site conveyance, fuel, and secure storage. | Yes | No |
| 12. | Daily cleanup of all areas associated with work. | Yes | No |
| 13. | Final cleaning. | Yes | No |
| 14. | Provide full time superintendent for the duration of the project. | Yes | No |
| 15. | Mandatory attendance at weekly coordination meetings. | Yes | No |
| 16. | Acknowledge proper work attire and safety requirements as stated in the contract documents. Proper traffic control to allow continual safe access to each campus. | Yes | No |
| 17. | All layout associated with the work of this Bid Category. | Yes | No |

B. You have re-reviewed the documents and understand the Scope of the Work. Are there any items that need to be identified or require clarification? Yes No

If yes, please identify item.

1. _____
2. _____
3. _____
4. _____
5. _____

Is (are) the cost(s), as applicable, included in your proposal items? Yes No

POST BID INTERVIEW

C. Review bid alternatives

ALTERNATE #1 – Lomitas North End Asphalt R&R

Yes No

ALTERNATE #2 – Montessori South End Asphalt R&R

Yes No

ALTERNATE #3 – Del Rey North End Asphalt R&R

Yes No

D. Review Allowances

Contractor understands that the allowance is to be used at the sole discretion of the District.

Yes No

Contractor understands that any remaining allowance will be refunded to the District at the completion of the project.

Yes No

D. Are you offering any unsolicited alternates or substitutions as part of bid?

Yes No

1. _____

2. _____

E. Are the plans and specifications clear and understandable to your satisfaction?

Yes No

VI. SCHEDULE:

A. Do you acknowledge and agree to the stipulated completion dates and milestones in the Contract?

Yes No

B. You understand that the "Project Schedule" are tentative and that the Construction Manager reserves the right to modify the phasing and/or schedule as necessary to accommodate the work of the project.

Yes No

C. Do you acknowledge and agree to the requirements to provide a designated project superintendent and project scheduler/manager for the duration of the project who will

POST BID INTERVIEW

attend weekly schedule meetings (in addition to weekly coordination meetings) and associated backcharge for failure to attend? Yes No

D. Will you comply with the schedule requirements for deliverables? Yes No

E. Do you understand that there will be no access to the front main school entrance? That only access will be along fire lane. That fire lane will be returned to District for use at end of each working day. Yes No

F. It is understood the Project schedule is critical. Can you accelerate any and all schedule activities if the requirement occurs? Yes No

If not, what must change and why? _____

H. Identify critical materials, deliveries and dependencies, including Owner Furnished items that could affect the completion of your work.

1. _____
2. _____
3. _____
4. _____
5. _____

I. You have reviewed Preliminary Construction Schedule in SPECIAL CONDITIONS, and Section 00 10 00, GENERAL REQUIREMENTS and you understand your work must be completed in accordance with the **timeline identified in the Special Conditions**. You further understand the District **MAY** assess liquidated damages if you fail to meet the Schedule timeline requirements. You further understand delays by you may cause District's vendors to be delayed, and that you **WILL**

accelerate your work upon written direction by the CONSTRUCTION
MANAGER. Yes No

CRITICAL DATES

PROJECT DURATION

31 working days

Projected Milestone Dates

Notice to Proceed	Pending Board Approval
Provide Schedule of Values	5 days from Contract Award
All Submittals received by Construction Manager	5 days from Notice to Proceed
All Shop Drawings received by Construction Manager	10 days from Notice to Proceed
Mobilize	Per published schedule

You agree that failure to meet the date is just cause for the DISTRICT to assess and retain Liquidated Damages in accordance with the Contract Documents.

VII. CONTRACTOR COMMENTS / SUGGESTIONS:

1. _____
2. _____
3. _____
4. _____

VIII. CONTRACTOR

NOTE: You agree the information contained herein is part of your contractual obligations. Your signature acknowledges your agreement to perform all work discussed herein. By executing the contract for this work, you agree to perform this work and acknowledge that the work is required by the contract and abide by all requirements of the contract.

You understand that the Post Bid Interview is a tool used by the District and the Construction Manager for the purposes of evaluating your bid for completeness prior to entering into a formal agreement. This document does not relieve the contractor from providing or performing any work specifically identified in the contract documents as pertaining to this Bid. Identification by the contractor of specific work not included in the bid price may result in disqualification of the bid.

The foregoing information is true and accurate, and I am authorized to sign as an office of the company I am representing.

Company Name

Signature: _____ Title: _____

Date: _____

Victor Elementary School District

Signature: _____ Title: _____

Date: _____

Construction Manager

Signature: _____ Title: _____

Date: _____

END OF SECTION

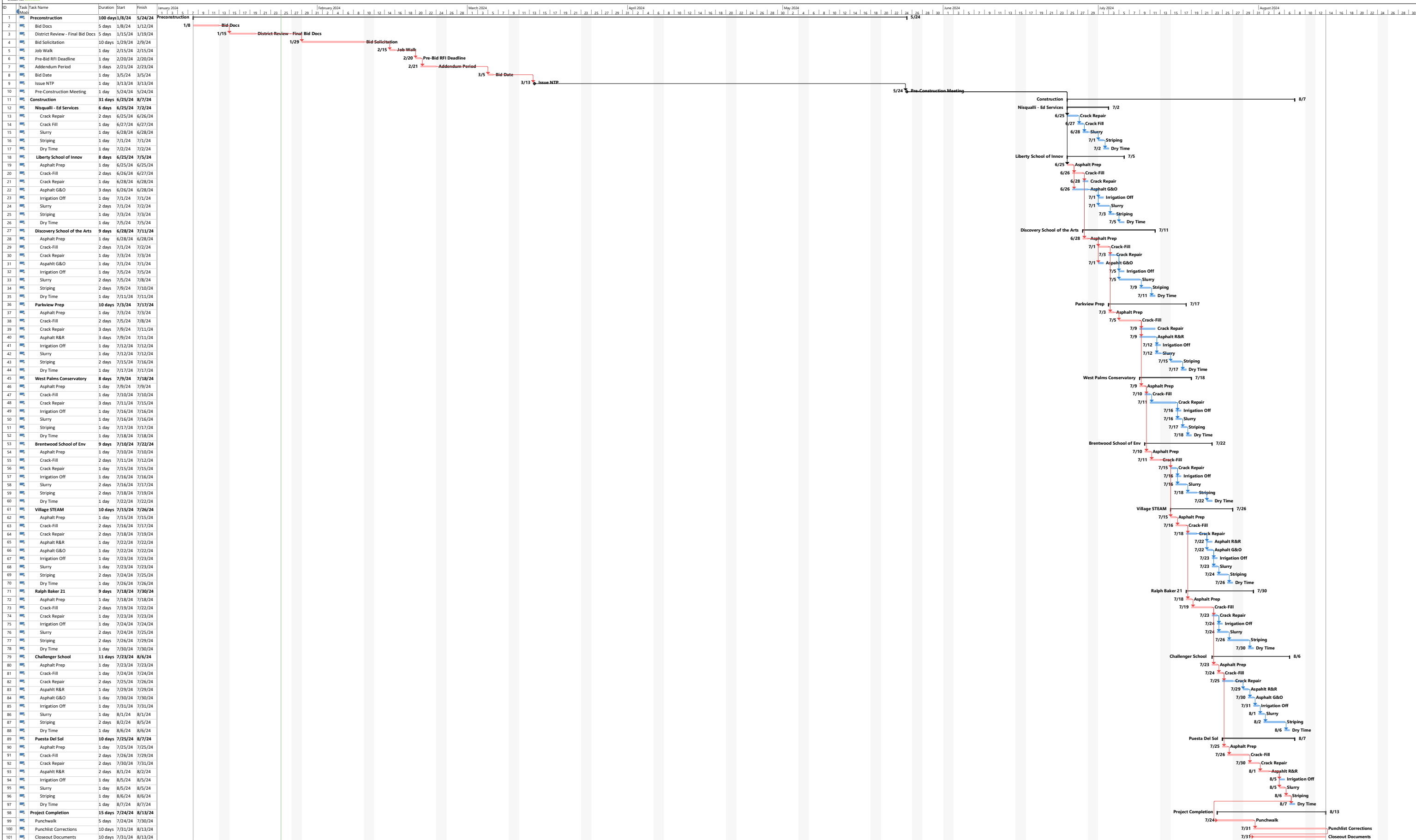

PLANS & SPECIFICATIONS



Erickson-Hall Construction
An Employee Owned Company

11810 Pierce St, Unit 150 Riverside, CA 92505. T: 951.358.0738

EHCC PROJECT NO. 4403

ASPHALT, SEAL COAT, STRIPING SCOPE OF WORK / SPECIFICATIONS

1. HOT RUBBERIZED CRACKFILL / ASPHALT PATCH

- a. Project to include crack fill and crack repair as specified on the site maps.
- b. As highlighted on the maps, some areas require removal & replacement or grinding & overlay. Grind out 1" of asphalt, install tack coat, overlay with 1"-2" of asphalt as required.
- c. Cracks 1/8" to 3/4" wide- clean and filled with a hot rubberized crack fill material. Rubberized crack filling requires that all existing crack faces are clean of dirt, debris, and vegetation. All moisture must be removed from all existing cracks prior to filling. Apply "Hot Pour Crack Filler by GuardTop" or equiv. modified self-leveling asphalt composition sealant at approx. 380 degrees F.
- d. Wherever cracks are greater than 3/4", contractor to follow detail A and to use compacted Type 3 "D Mix" fine hot mix asphalt material.
- e. Wherever asphalt meets concrete with cracks greater than 3/4", contractor to follow detail B and to use compacted Type 3 "D Mix" fine hot mix asphalt material.
- f. Potholes are to be cut out with straight lines, filled, and compacted along with edge sealing.

2. SEAL COAT

- a. Project includes slurry coat of all areas with two coats of slurry coat as specified below.
- b. The contractor shall ensure that the first coat of slurry is completely dry prior to applying the second coat.
- c. Clean & prepare existing asphalt using high power blowers and brooms as necessary. Adequate preparation will be a critical element and required to be inspected prior to placement of seal coat product.
- d. Apply (2) coats of "GuardTop Asphalt Based Sealcoat" industrial pavement seal material. Second coat to be applied after the first coat has completely dried. Substitutions will be allowed upon District review and approval.
- e. The contractor shall clean any overspray / splash of material upon application on surrounding non-asphalt surfaces.
- f. The contractor shall include seal coat between portables where accessible only.
- g. Project to include all highlighted areas on the maps.

ASPHALT, SEAL COAT, STRIPING SCOPE OF WORK / SPECIFICATIONS

3. STRIPING

- a. Project to include restriping of all existing lines/ arrows/ signage/ etc. on the parking lot(s) and playground(s). Re-stripe shall follow the existing layout unless noted otherwise.
- b. Contractor shall include striping of all curbs and parking bumpers throughout the site to match the existing color.
- c. Where striping is on asphalt and passes through concrete, contractor shall continue striping as required to complete the line.
- d. Apply one (1) coat of "ENNIS" traffic paint to sealed areas (Restripe), apply two (2) coats traffic paint to newly paved areas. (New layout will be at the district's request.)
- e. The contractor shall field document as part of the preparation process the existing striping, playground stipes, fire lane stripe, such that equal striping of existing lines will be provided. Use of drone technology shall also be acceptable to document existing striping conditions when students are not present.
- f. The contractor shall provide stencils as required for replacement of striping to match existing.
- g. The contractor shall coordinate with District on any additional striping required prior to finalizing striping, additional striping required by the district after the bid submission shall be submitted at an additional cost.



GuardTop® High Performance Asphalt Based Sealcoat

Revised 1/21/21

GuardTop® Asphalt Based Sealcoat Product Specification for California

GuardTop is a mineral and fiber reinforced asphalt emulsion blended with special additives for outstanding adhesion, flexibility, and durability. GuardTop restores the asphalt binder lost through oxidation and weathering, while providing a durable surface treatment. GuardTop helps your pavements look new again, providing the surface with a deep, rich black color and protection against raveling and cracking due to aggregate loss.

Specifications	Minimum	Maximum	Test Method
Typical Density-lbs./gal	10.5	12	ASTM D 2939.07
Nonvolatile Components by Weight	60%	70%	ASTM D 2939.08
Asphalt Content by Weight	14%	35%	ASTM D 2939.21
Fine Aggregate Content by Weight	31%	50%	GuardTop Report
VOC Content by Volume	0%	3%	ASTM D 244-89
Requirements		Results	
Accelerated Weathering (2 yrs)	No Material Deterioration After Exposure	Passes/Excellent	Federal Spec TT-C-555B
Resistance to Wind Driven Rain (98mph)	No Leaks or Weight Gain	Passes/Excellent	Federal Spec TT-C-555B
Ultraviolet Resistance (12 yrs.)	No Cracking, Peeling, Chipping, or Flaking	Passes/Excellent	GuardTop Report
Color as Received	Black	Pass	GuardTop Report
Cured Film	Deep Black	Pass	GuardTop Report
Material Uniformity	Uniform	Pass	ASTM D 2939.05
Flashpoint	160°F	Pass	ASTM D 2939.12
Drying Time, firm set	Within 8 Hours	Pass	ASTM D 2939.13
Resistance to Heat	No Sagging or Slipping	Pass/None	ASTM D 2939.14
Resistance to Water	No Cracking	Pass	ASTM D 2939.15
Flexibility	Pass	Pass	ASTM D 2939.16 (1)
Direct Flame Test	No continued combustion or slippage and run-down	Pass/None	ASTM D 2939.20
Wet Film Continuity	Uniform consistency	Pass	ASTM D 2939.22
Wet Flow	Uniformly homogenous	Pass	ASTM D 2939.19 (2)
Wet Track Abrasion Test (1 hr.)	0	15	ASTM 3910
Wet Track Abrasion Test (6 day)	0	15	ASTM 3910
Flashpoint	450° F	Pass	ASTM D 92 (3)
Softening Point	140° F	Pass	ASTM D 36 (4)

- (1) Flexibility test (ASTM D 2939.16) performed at 23° C.
- (2) Wet flow test (ASTM D 2939.19) performed at an angle 10° above horizontal.
- (3) Flashpoint (ASTM D 92) measured on asphalt before emulsification.
- (4) Softening point (ASTM D 36) measured on asphalt before emulsification

This product meets and exceeds the California Greenbook (2000) 203-9 specification

Surface Preparation

1. Clean and fill all cracks 1/4" and larger with crack filler. Larger cracks may require several applications. For best results, it is recommended that all broken asphalt be removed and patched with new asphalt. It is also suggested that extreme low spots be filled with new asphalt. **New asphalt patches should cure for 30 days and replaced asphalt 4" or more in**



GuardTop® High Performance Asphalt Based Sealcoat

Revised 1/21/21

depth should cure for 180 days minimum before application of GuardTop.

2. Sealcoats will not adhere to surfaces with excessive oil and grease. For a quality job, clean all oil and grease deposits with a degreasing solution using a stiff bristle broom or a power operated cleaner. Areas completely saturated are recommended to be removed and replaced with new asphalt. Then apply GuardTop Oil Seal to all oil and grease stained surfaces with a small broom insuring full coverage over the stain.
3. After all pavement repairs have been completed, the surface should be clean and free of all dirt, debris and loose graveled particles. Please note that dirt and loose debris will restrict the adherence of the sealcoat. To clean the surface, use a power broom, power blower and/or flush the surface with high pressure water.
4. It is recommended that the surface be sprayed with a mist of water in an amount that will leave the surface damp and free of standing water or puddles. The misting procedure is critical when the ambient temperature is hot and on bright sunny days or when the pavement is excessively aged and porous.
5. For excessively weathered surfaces, a primer or fog seal should be applied to the surface. The primer should consist of a 50/50 mixture of SS1-h and water. Apply the mixture to the surface by spray and let dry before applying GuardTop material.

Application

1. GuardTop material should be mixed with water to obtain a desired consistency before application. It is recommended that the maximum dilution should be 20% water to 80% GuardTop material. Apply GuardTop using a truck mounted tank, wheeled container, or can. Spread in continuous parallel lines by means of rubber faced squeegees, brooms or spray technique. On excessively rough areas consult your manufacturer's representative.

It is recommended that two coats of GuardTop be used during application to ensure a long lasting surface.

2. GuardTop should be allowed to dry a minimum of 24 hours before heavy traffic is permitted. Please note that when asphalt is cold, in shade or the ambient temperature is below 75°, drying time may need to be extended. GuardTop should not be applied in temperatures below 55° and extra care should be taken in temperatures exceeding 100°. Material should not be applied within 48 hours of forecasted rain, as rain may affect curing of asphalt sealcoat products.

Application Rates

The following table can be used as a guideline of GuardTop coverage per square foot of surface area. This table is based on two coats prior to water dilution of the product. Please note that this is only a guideline and exact coverage depends upon both the condition of existing pavement and the surface condition desired after application

Surface	Recommendation Per Sq. Foot	Per Sq. Yard
Extremely smooth surface	0.02 Gallon	0.18 Gallon
Smooth dense surface	0.0235 Gallon	0.225 Gallon
Medium surface	0.03 Gallon	0.27 Gallon
Rough, aged surface	0.035 Gallon	0.315 Gallon
Excessively rough surface	Consult manufacturer's representative	Consult manufacturer's representative

Caution

Do not store in extremely warm conditions. Keep from freezing.

Packaging

Bulk, 5 gallon pails and 55 gallon drums.



Hot Pour Crack Filler by GuardTop® Product Specification

Hot Pour Crack Filler by GuardTop®

GuardTop Hot Pour Crack Filler Product Specification

Hot Pour Crack Filler by GuardTop is a high performance hot applied polymer modified, recycled rubber asphalt crack sealant. It is formulated to provide a resilient, firm, fast curing sealant eliminating the risk of “tire pick-up”, and which is also highly resistant to power steering markings on pavements having high surface temperatures. In its molten state, Hot Pour Crack Filler by GuardTop has excellent flow properties ensuring total penetration of the cracks without voids or air pockets. Hot Pour Crack Filler by GuardTop is particularly suitable for use on both asphalt and concrete pavements in warm and hot climates. Hot Pour Crack Filler by GuardTop is designed for parking lots, streets and highways where heavy traffic is a concern.

Surface Preparation

Hot Pour Crack Filler by GuardTop must be applied to a clean, dry surface, free from all loose material, and all vegetation and detritus must be removed. Application to wet or dusty surfaces will result in adhesion failures. All joints and cracks should be thoroughly cleaned with the use of a hot air gas lance prior to application.

Application

Hot Pour Crack Filler by GuardTop sealant must be heated in a purpose built pre-heater equipped with mechanical agitation and an oil jacket. Application may be done by wand or wheeled banding machine.

Coverage per Gallon

Indefinite - For estimation purpose – up to 80 linear feet of ½” X ½” depth cracks

Caution

Exercise extreme caution when handling hot sealant. Wear gloves, long sleeved shirts, face shields, safety boots and other safety clothing at all times. Do not allow water to come in contact with hot material. In the event of fire, extinguish with Co2, Foam or Dry Chemical.

Packaging

Hot Pour Crack Filler by GuardTop is supplied in recyclable cardboard cartons. Each carton comprises of 30 lbs. of sealant in a dissolvable bag.

Meets or exceeds the following specifications:

Cone Penetration 25°C/77°F (D5329)	25+/-5
Cone Penetration 46°C/115°F (D5329)	70 Max
Softening Point (D36)	105°C/220°F Min
Resilience (D5329)	40% Min
Viscosity 193°C/380°F (D4402)	20-30 Poise
Flow 60°C/140°F (D5329)	0 Max
Flexibility (90° bend 1 1/8 mandrel 0°C/32°F)	Pass
Flash Point (COC)	>440°F Min
Asphalt Compatibility	Pass
Application Temperature	193°C/380°F Max
Safe heating temperature	204°C/400°F Max
VOC	0 g/1

: REMOVE & REPLACE

: GRIND & OVERLAY

Permanent Buildings
 Relocatable Buildings

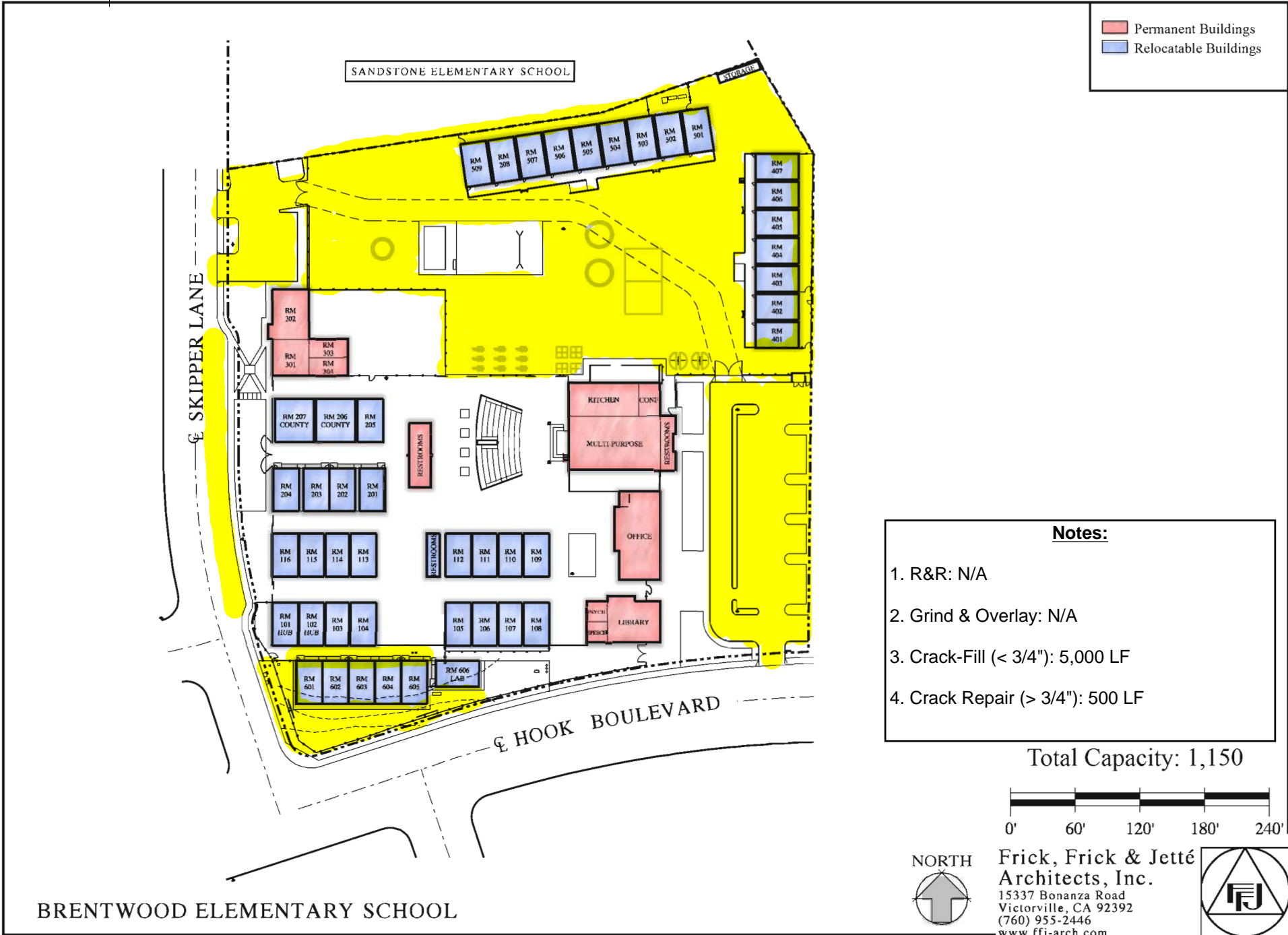

Notes:

1. R&R: N/A
2. Grind & Overlay: N/A
3. Crack-Fill (< 3/4"): 5,000 LF
4. Crack Repair (> 3/4"): 500 LF

Total Capacity: 1,150

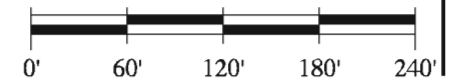

Frick, Frick & Jetté
Architects, Inc.
15337 Bonanza Road
Victorville, CA 92392
(760) 955-2446
www.ffj-arch.com



BRENTWOOD ELEMENTARY SCHOOL

: REMOVE & REPLACE

: GRIND & OVERLAY

- Notes:**
1. R&R: 20 SF
 2. Grind & Overlay: N/A
 3. Crack-Fill (< 3/4"): 2,500 LF
 4. Crack Repair (> 3/4"): 500 LF

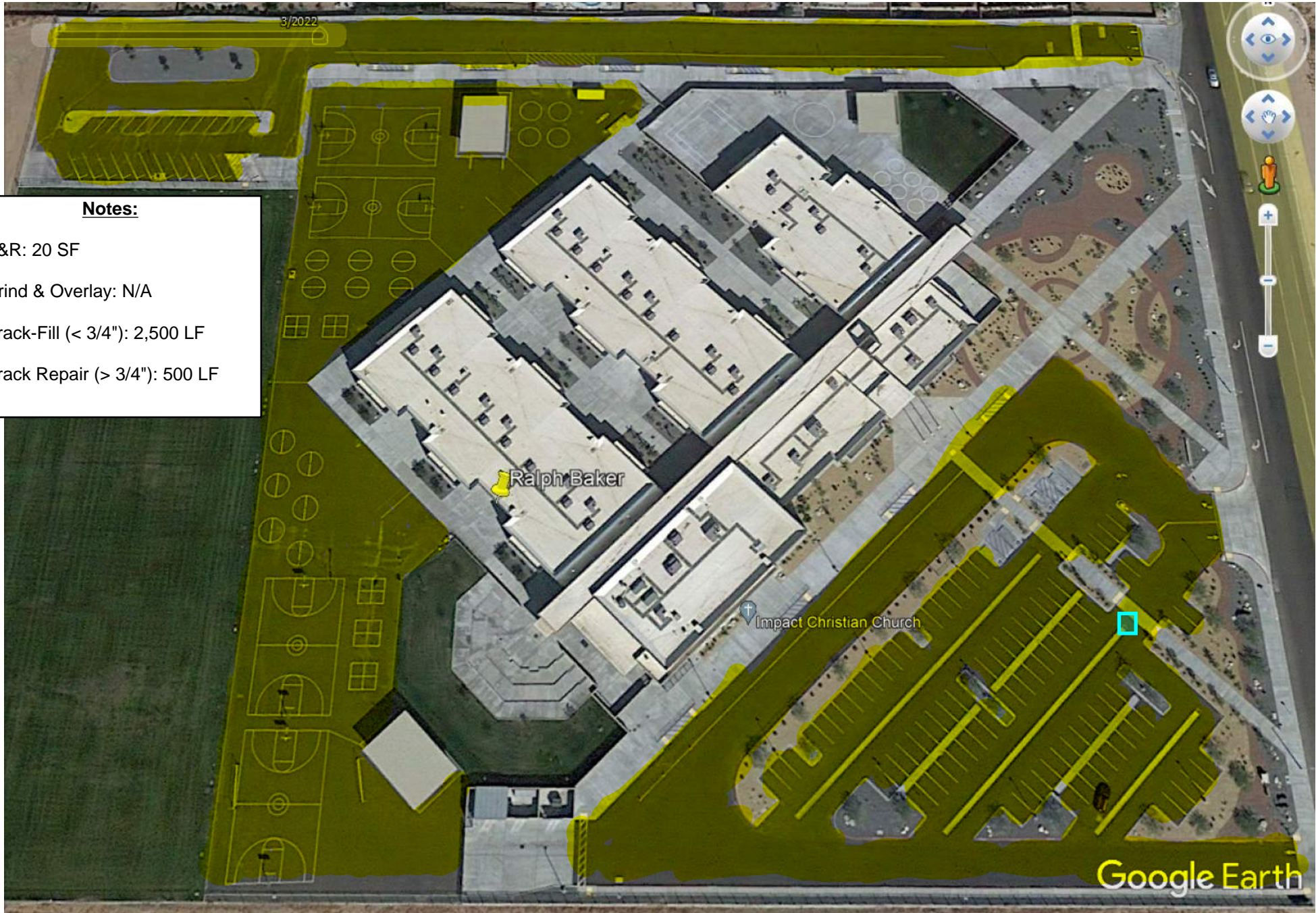

RALPH BAKER

: REMOVE & REPLACE

: GRIND & OVERLAY

Permanent Buildings
 Relocatable Buildings

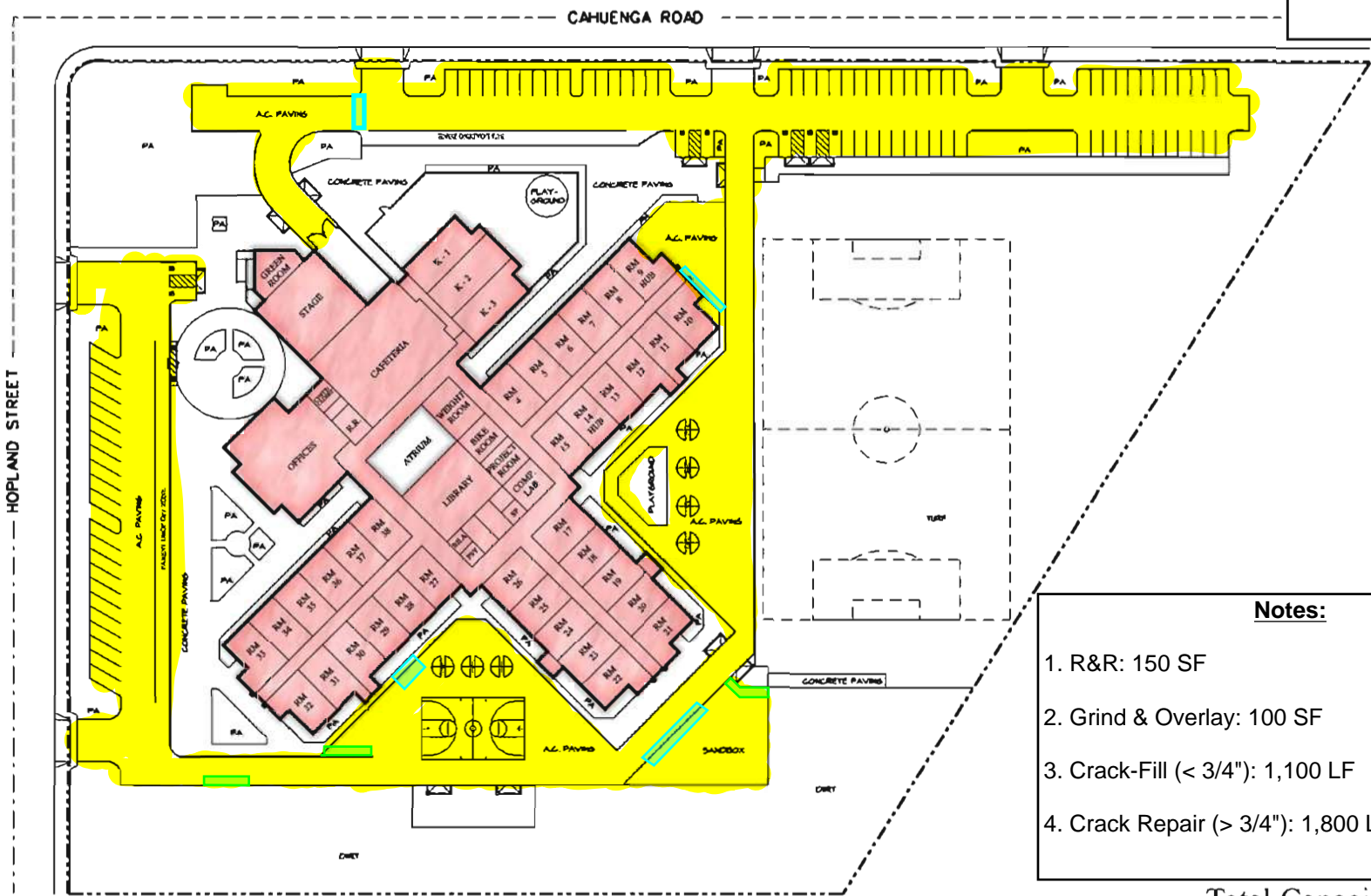

- Notes:**
- 1. R&R: 150 SF
 - 2. Grind & Overlay: 100 SF
 - 3. Crack-Fill (< 3/4"): 1,100 LF
 - 4. Crack Repair (> 3/4"): 1,800 LF

Total Capacity: 1,025

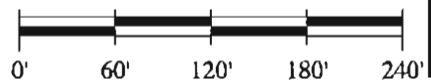

CHALLENGER SCHOOL OF SPORTS AND FITNESS





Frick, Frick & Jetté Architects, Inc.
15337 Bonanza Road
Victorville, CA 92392
(760) 955-2446
www.ffj-arch.com



 : REMOVE & REPLACE

 : GRIND & OVERLAY

 Permanent Buildings
 Relocatable Buildings

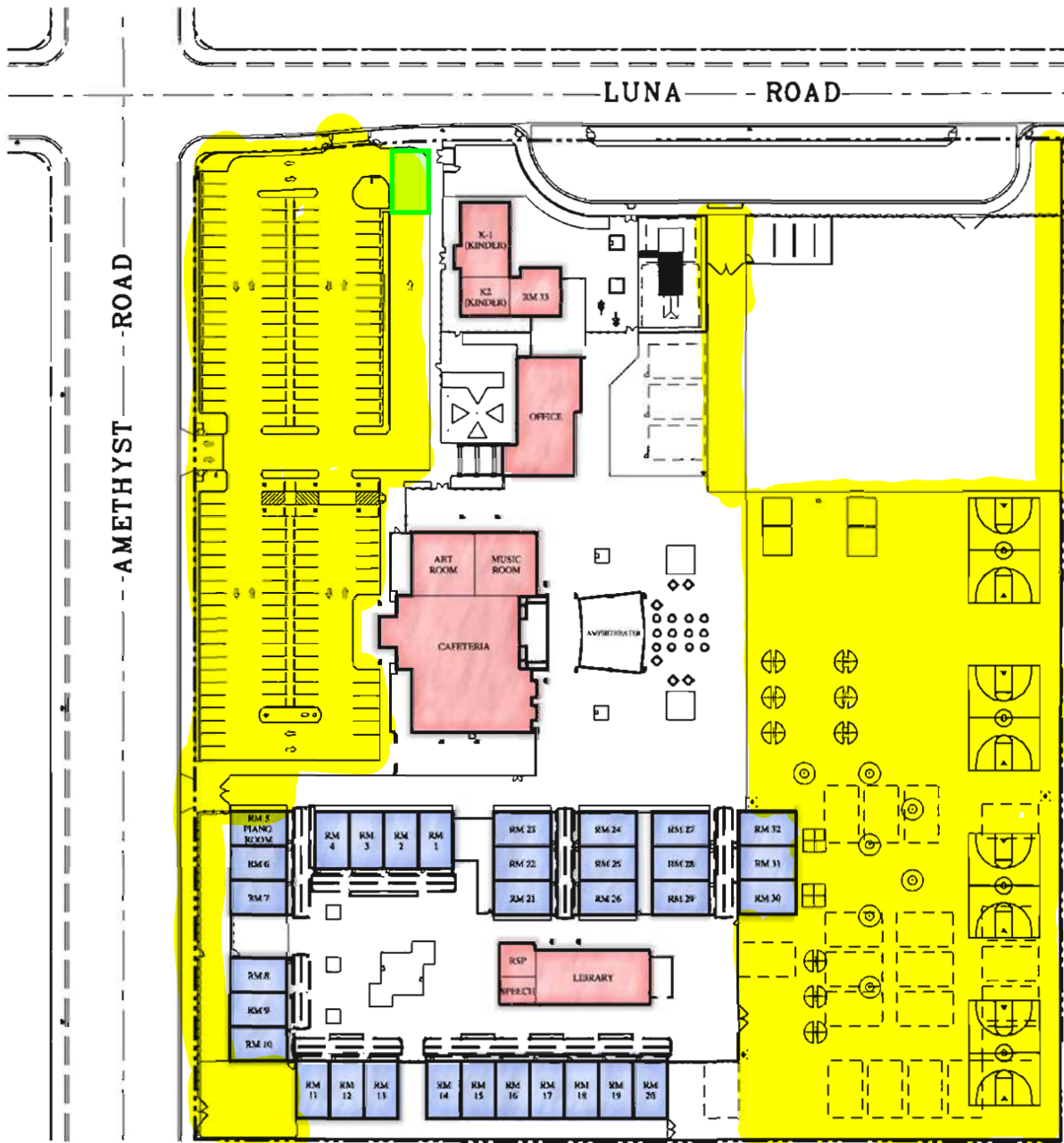

Notes:

- 1. R&R: N/A
- 2. Grind & Overlay: 100 SF
- 3. Crack-Fill (< 3/4"): 6,000 LF
- 4. Crack Repair (> 3/4"): 800 LF

Total Capacity: 925

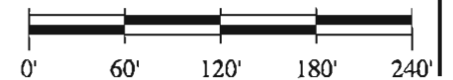

Frick, Frick & Jetté
Architects, Inc.
15337 Bonanza Road
Victorville, CA 92392
(760) 955-2446
www.ffj-arch.com



DISCOVERY SCHOOL OF THE ARTS

: REMOVE & REPLACE

: GRIND & OVERLAY

Permanent Buildings
 Relocatable Buildings

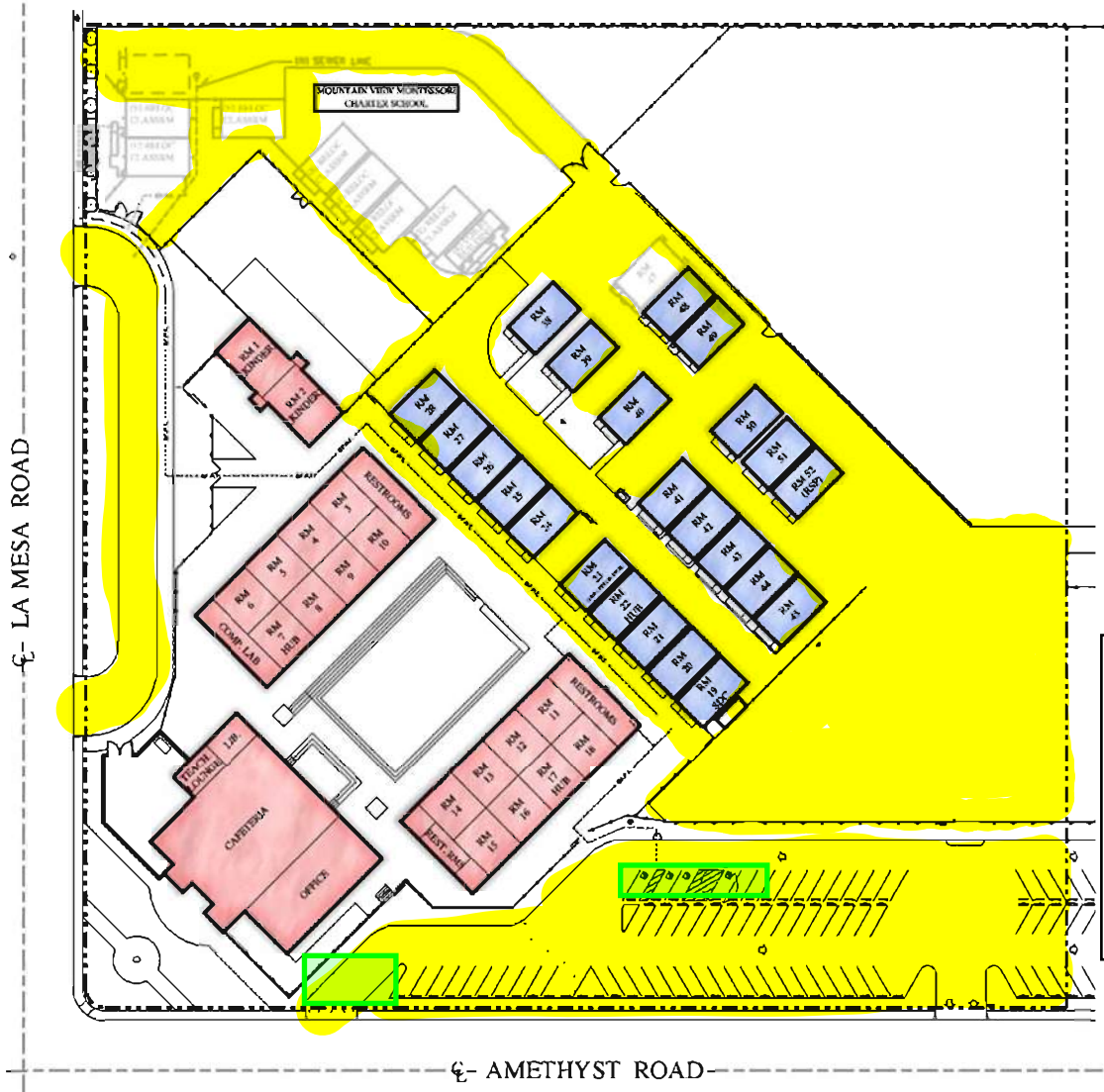

Notes:

- 1. R&R: N/A
- 2. Grind & Overlay: 6,000 SF
- 3. Crack-Fill (< 3/4"): 1,000 LF
- 4. Crack Repair (> 3/4"): 300 LF

Total Capacity: 1,050

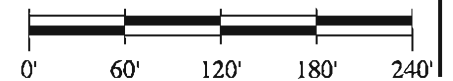

Frick, Frick & Jetté
Architects, Inc.
15337 Bonanza Road
Victorville, CA 92392
(760) 955-2446
www.ffj-arch.com



LIBERTY ELEMENTARY SCHOOL

VICTOR ELEMENTARY SCHOOL PARKING LOT SLURRY COAT AT LIBERTY SCHOOL OF CREATIVITY AND INNOVATION VICTOR ELEMENTARY SCHOOL DISTRICT VICTORVILLE, CALIFORNIA

IDENTIFICATION STAMP
DIV. OF THE STATE ARCHITECT
APP: 04-119213 INC:
REVIEWED FOR:
SS FLS ACS
DATE: 06/02/2020



SOUTHERN CALIFORNIA
8163 ROCHESTER AVENUE, SUITE 100
RANCHO CUCAMONGA
CALIFORNIA 91730-0729
TEL: 909-987-0909
www.wlccarchitects.com

GENERAL NOTES

1. THESE DRAWINGS DO NOT CONTAIN THE NECESSARY COMPONENTS FOR CONSTRUCTION SAFETY.
2. LOCATIONS OF ALL UTILITIES SHOWN ARE APPROXIMATE AND CONTRACTOR SHALL EXERCISE EXTREME CAUTION IN EXCAVATING AND TRENCHING ON THIS SITE TO AVOID INTERCEPTING EXISTING PIPING OR CONDUITS. IT SHALL BE THE RESPONSIBILITY OF THE CONTRACTOR TO LOCATE ALL EXISTING UTILITIES WHETHER SHOWN HEREON OR NOT AND TO PROTECT THEM FROM DAMAGE. THE ARCHITECT IS NOT RESPONSIBLE FOR THE LOCATION OF UNDERGROUND UTILITIES OR STRUCTURES WHETHER OR NOT SHOWN OR DETAILED AND INSTALLED BY ANY OTHER CONTRACT. THE CONTRACTOR SHALL IMMEDIATELY NOTIFY THE ARCHITECT SHOULD ANY UNIDENTIFIED CONDITIONS BE DISCOVERED. THE CONTRACTOR SHALL BEAR ALL EXPENSE OF REPAIR OR REPLACEMENT OF UTILITIES OR OTHER PROPERTY DAMAGED BY OPERATIONS IN CONJUNCTION WITH THE EXECUTION OF THIS WORK.
3. THESE DOCUMENTS AND THE IDEAS AND DESIGNS INCORPORATED HEREIN, AS AN INSTRUMENT OF PROFESSIONAL SERVICE, ARE THE PROPERTY OF WLC ARCHITECTS, INC., AND ARE NOT TO BE USED, IN WHOLE OR IN PART, FOR ANY OTHER PROJECT WITHOUT THE WRITTEN AUTHORIZATION OF WLC ARCHITECTS, INC.
4. THE WORK SHOWN ON THESE DRAWINGS AS EXISTING CONDITIONS WAS PREPARED FROM INFORMATION FURNISHED BY THE OWNER. WHILE THIS INFORMATION IS BELIEVED TO BE RELIABLE, WLC ARCHITECTS, INC. IS NOT RESPONSIBLE FOR THE ACCURACY OR ADEQUACY OF ANY WORK SHOWN AS EXISTING NOR IS WLC ARCHITECTS, INC. RESPONSIBLE FOR ANY ERRORS OR OMISSIONS WHICH MAY HAVE BEEN INCORPORATED INTO THESE DRAWINGS AS A RESULT.
5. CONTRACTOR SHALL POSSESS A CLASS B OR THE APPROPRIATE CLASS C CONTRACTOR'S LICENSE PURSUANT TO PUBLIC CONTRACT CODE SECTION 3300 AND BUSINESS AND PROFESSIONS CODE SECTION 7028.15. THE CONTRACTOR MUST MAINTAIN THE LICENSE THROUGHOUT THE DURATION OF THIS CONTRACT.
6. FIRE SAFETY DURING CONSTRUCTION
 - A. GENERAL: FIRE SAFETY DURING CONSTRUCTION SHALL COMPLY WITH CALIFORNIA FIRE CODE (CFC) CALIFORNIA CODE OF REGULATIONS (CCR) TITLE 24, PART 9, CHAPTER 5 AND CHAPTER 33.
 - B. ACCESS ROADS: FIRE DEPARTMENT ACCESS ROADS SHALL BE ESTABLISHED AND MAINTAINED IN ACCORDANCE WITH CHAPTER 5, SECTION 501.4 AND CHAPTER 33, SECTION 3310.
 - C. WATER SUPPLY: WATER MAINS AND HYDRANTS SHALL BE OPERATIONAL IN ACCORDANCE WITH CHAPTER 5, SECTION 501.4 AND CHAPTER 33, SECTION 3312.
 - D. BUILDING ACCESS: ACCESS TO BUILDINGS FOR THE PURPOSE OF FIREFIGHTING SHALL BE PROVIDED. CONSTRUCTION MATERIAL SHALL NOT BLOCK ACCESS TO BUILDINGS, HYDRANTS OR FIRE APPLIANCES.
 - E. ALTERATIONS OF BUILDINGS: SHALL COMPLY WITH APPLICABLE PROVISIONS OF CHAPTER 33.
 - F. DEMOLITION OF BUILDINGS: SHALL COMPLY APPLICABLE PROVISIONS OF CHAPTER 33.
 - G. FIRE WATCH: MAINTAIN FIRE WATCH WHEN REQUIRED BY THE BUILDING OFFICIAL AND WHEN EXISTING FIRE PROTECTION SYSTEMS ARE SHUT DOWN FOR ALTERATIONS IN ACCORDANCE WITH CHAPTER 33, SECTION 3304.5. FIRE WATCH SHALL REMAIN IN EFFECT UNTIL EXISTING FIRE PROTECTION SYSTEMS ARE RETURNED TO SERVICE OR AS ALLOWED BY THE BUILDING OFFICIAL.
8. ALL WORK SHOWN ON THESE DRAWINGS SHALL COMPLY WITH THE REQUIREMENTS OF TITLE 24, CALIFORNIA CODE OF REGULATIONS (CCR).

- 9.- CHANGES TO THE APPROVED DRAWINGS AND SPECIFICATIONS SHALL BE MADE BY AN ADDENDUM OR A CONSTRUCTION CHANGE DOCUMENT APPROVED BY THE DIVISION OF THE STATE ARCHITECT, AS REQUIRED BY TITLE 24, CCR, PART 1, SECTION 4-338.
- 10.- GRADING PLANS, DRAINAGE IMPROVEMENTS, ROAD AND ACCESS REQUIREMENTS AND ENVIRONMENTAL HEALTH CONSIDERATIONS SHALL COMPLY WITH ALL LOCAL ORDINANCES.
- 11.- CONTRACTOR TO INSTALL AND/OR ASSUME RESPONSIBILITY OF EXISTING TEMPORARY CONSTRUCTION FENCE AS REQUIRED TO PROVIDE A CLEAR PATH OF TRAVEL AROUND ALL CONSTRUCTION AREAS AND MATERIALS WITHOUT RESTRICTING STUDENT TRAFFIC. AT THE END OF CONSTRUCTION, REPAIR ALL DAMAGE TO CONCRETE OR AC PAVING TO DISTRICT'S SATISFACTION.
- 12.- THE INTENT OF THESE DRAWINGS AND SPECIFICATIONS IS THAT THE WORK OF THE ADDITION, ALTERATION OR RECONSTRUCTION IS IN COMPLIANCE WITH THE REQUIREMENTS OF TITLE 24, CALIFORNIA CODE OF REGULATIONS. SHOULD ANY CONDITIONS SUCH AS DETERIORATION OR NON-COMPLYING CONSTRUCTION BE DISCOVERED WHICH IS NOT IDENTIFIED BY THE CONTRACT DOCUMENTS WHEREIN THE FINAL WORK WOULD NOT COMPLY WITH THE REQUIREMENTS OF TITLE 24, CALIFORNIA CODE OF REGULATIONS. THE CONTRACTOR SHALL IMMEDIATELY NOTIFY THE OWNER AND THE ARCHITECT OF THE CONDITION IN WRITING. NECESSARY INFORMATION REQUIRED TO CORRECT THE CONDITIONS ENCOUNTERED WILL BE ISSUED BY THE ARCHITECT. A CHANGE ORDER MAY BE ISSUED TO ADJUST THE CONTRACT SUM OR TIME COMMENSURATE WITH THE AMOUNT OF ADDITIONAL WORK REQUIRED IF ANY. A CONSTRUCTION CHANGE DOCUMENT SHALL BE APPROVED BY THE DIVISION OF THE STATE ARCHITECT PRIOR TO PROCEEDING WITH THE WORK REQUIRED BY THE CHANGE ORDER.
- 13.- ALL SLOPE AND CROSS SLOPE OF ACCESSIBLE ROUTE PAVING INDICATED ON THESE DRAWINGS WAS DESIGNED IN COMPLIANCE WITH THE 2010 ADA STANDARDS FOR ACCESSIBLE DESIGN AND THE THE ACCESSIBILITY STANDARDS OF THE CALIFORNIA BUILDING CODE, (CBC) TITLE 24, PART 2, CHAPTER 11B OF THE CALIFORNIA CODE OF REGULATIONS (CCR). STRICT EXECUTION OF THE SLOPE AND CROSS SLOPE OF ACCESSIBLE ROUTE PAVING IS THE SOLE RESPONSIBILITY OF THE CONTRACTOR. SHOULD A CONDITION PRESENT ITSELF THAT WOULD RESULT IN AN INSTALLATION OTHER THAN WHAT IS INDICATED IN THESE DRAWINGS, WLC ARCHITECTS, INC. SHALL BE NOTIFIED IN WRITING AND A COMPLIANT RESOLUTION WILL BE FORMULATED.

NOTE: THIS PROJECT IS AN ACCESS ONLY PROJECT. THIS DSA # WILL NOT BE ABLE TO BE USED TO IDENTIFY THE ACCESSIBLE PARKING FOR ANY FUTURE PROJECT AS THERE IS NO INSPECTION CARD AND NO DSA FIELD PRESENCE.

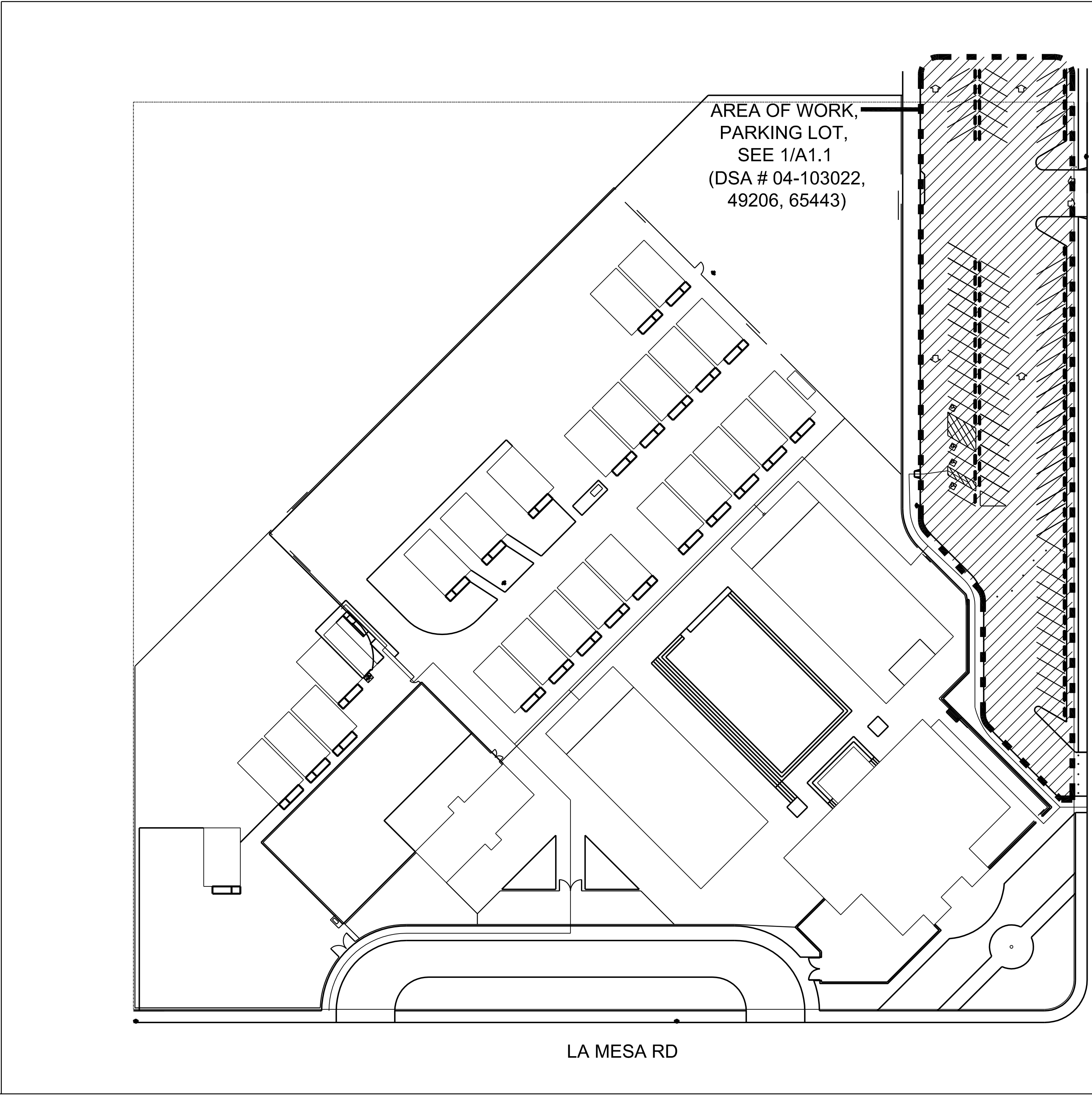

PROJECT TEAM

<p>OWNER VICTOR ELEMENTARY SCHOOL DISTRICT 12219 SECOND AVENUE VICTORVILLE, CA 92395 PHONE: (760) 245-1691 FAX: (760) 245-6245</p>	<p>ARCHITECT WLC ARCHITECTS, INC. 8163 ROCHESTER AVE., SUITE 100 RANCHO CUCAMONGA, CA 91730 PHONE: (909) 987-0909 FAX: (909) 980-9980</p>
---	--

SCOPE OF WORK DESCRIPTION

THE SCOPE OF THE WORK AS STATED BELOW IS FOR DSA PLAN REVIEW PURPOSES ONLY AND DOES NOT CONSTITUTE A DETAILED AND FULL EXPLANATION OF THE REQUIREMENTS OF THE CONTRACT DOCUMENTS.
APPLYING SLURRY COATING AT EXISTING PARKING LOTS AND ASSOCIATED SITE WORKS.

DRAWING INDEX

DWG REF NO	DESCRIPTION
A0.1	GENERAL NOTES & PROJECT DIRECTORY & OVERALL SITE PLAN
A1.1	ENLARGED SITE PLANS
A2.1	SITE DETAILS

TOTAL: 3 SHEETS

PROJECT ADDRESS:
12900 AMETHYST RD, VICTORVILLE, CA 92395

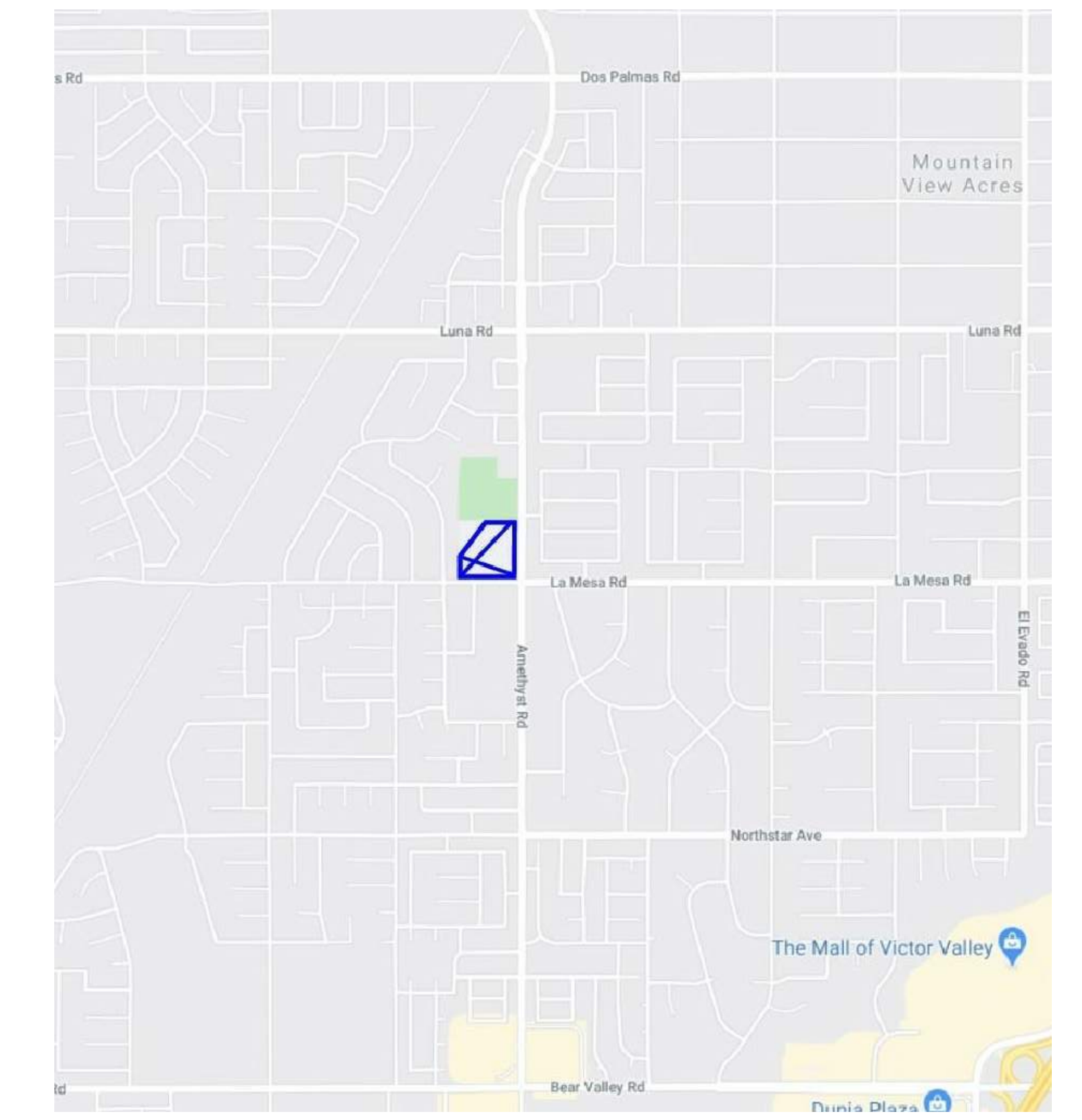

(E) SITE PLAN - OVERALL

1/48" = 1'-0"

VICINITY MAP

**VICTOR ELEMENTARY SCHOOL
PARKING LOT SLURRY COAT AT
LIBERTY SCHOOL OF CREATIVITY AND INNOVATION**
VICTOR ELEMENTARY SCHOOL DISTRICT
VICTORVILLE, CA

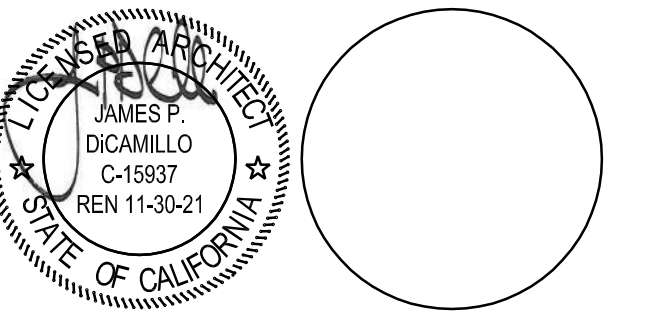

CONSULTANT

NO	DATE	BY	DESCRIPTION
REVISIONS			

DRAWN: _____ **CHECKED:** _____
DATE: 03/17/2020 **SCALE:** _____
PROJECT NUMBER: 2011200

**GENERAL NOTES
& PROJECT DIRECTORY
& OVERALL SITE PLAN**

DRAWING NUMBER: A0.1

NO	DATE	BY	DESCRIPTION
REVISIONS			

DRAWN:	CHECKED:
DATE: 03/17/2020	SCALE:
PROJECT NUMBER: 2011200	

GENERAL NOTES

DSA PR 15-01: REQUIRED INFORMATION FOR PATH OF TRAVEL UPGRADES ON CONSTRUCTION DOCUMENTS

"DESIGN PROFESSIONAL IN GENERAL RESPONSIBLE CHARGE STATEMENT: THE POT IDENTIFIED IN THESE CONSTRUCTION DOCUMENTS MEETS THE REQUIREMENTS OF THE CURRENT APPLICABLE CALIFORNIA BUILDING CODE (CBC) ACCESSIBLE PROVISION FOR PATH OF TRAVEL REQUIREMENTS FOR ALTERATIONS, ADDITIONS AND STRUCTURAL REPAIRS. AS PART OF THE DESIGN OF THIS PROJECT, THE POT WAS EXAMINED AND ANY ELEMENTS, COMPONENTS OF PORTIONS OF THE POT THAT WERE DETERMINED TO BE NON-COMPLIANT WITH THE CBC HAVE BEEN IDENTIFIED AND THE CORRECTIVE WORK NECESSARY TO BRING THEM INTO COMPLIANCE HAS BEEN INCLUDED WITHIN THE SCOPE OF THIS PROJECT'S WORK THROUGH DETAILS, DRAWINGS AND SPECIFICATIONS. INCORPORATED INTO THESE CONSTRUCTION DOCUMENTS. ANY NONCOMPLIANT ELEMENTS, COMPONENTS OR PORTIONS OF THE POT THAT WILL BE CORRECTED BY THIS PROJECT BASED ON VALUATION THRESHOLD LIMITATIONS OR A FINDING OF UNREASONABLE HARDSHIP ARE INDICATED IN THESE CONSTRUCTION DOCUMENTS.

DURING CONSTRUCTION, IF POT ITEMS WITHIN THE SCOPE OF THE PROJECT REPRESENTED AS CBC COMPLIANT ARE FOUND TO BE NONCONFORMING BEYOND REASONABLE CONSTRUCTION TOLERANCES, THE ITEMS SHALL BE BROUGHT INTO COMPLIANCE WITH THE CBC AS A PART OF THIS PROJECT BY MEANS OF A CONSTRUCTION CHANGE DOCUMENT"

- NOTE:
- 1.SLOPE OF PAVING AT ACCESSIBLE LOADING AREA NOT TO EXCEED 2% IN ANY DIRECTION.
 - 2.CONTRACTOR SHALL REPLACE ACCESSIBLE PARKING SIGN AND VAN PARKING SIGN AND INSTALL ON (E) POLE, AND VERIFY THE POLE IS ALIGN IN THE CENTER OF THE STALL AND 12" MIN FROM CURB FACE. RELOCATE POLE W/ (N) FOOTING IF POLE IS NOT ALIGN IN THE CENTER OF THE STALL AS NEEDED. PROVIDE (N) POLE W/ (N) FOOTING IF (E) ONE IS NOT IN PLACE.
 - 3.LOCATION OF WHEEL STOP IN ACCESSIBLE PARKING STALLS TO CONFORM WITH LOCATION AS SHOWN ON SHEET A2.1, RELOCATE AS NEEDED, AND INSTALL WITH (2) #4 STEEL DOWEL W/ 6" EMBEDMENT. WHEEL STOP SHALL BE PAINTED BLUE
 - 4.CONTRACTOR SHALL PAINT ALL CURB TOP AND FACE IMMEDIATELY ADJACENT TO ACCESSIBLE PARKING STALL BLUE
 - 5.CONTRACTOR SHALL INSTALL (N) TRUNCATED DOME IF (E) LOCATION OR CONFIGURATION AND SIZE DOES NOT MATCH OR CONFORM TO WHAT'S SHOWN ON APPROVED PLAN, OR IF (E) TRUNCATED DOME IS NOT RECESSED PER DET 18/A2.1

PARKING TABULATION

PARKING LOT	TOTAL STALLS	ACCESSIBLE STALLS REQUIRED	ACCESSIBLE STALLS PROVIDED
-	68	3	6

LEGEND

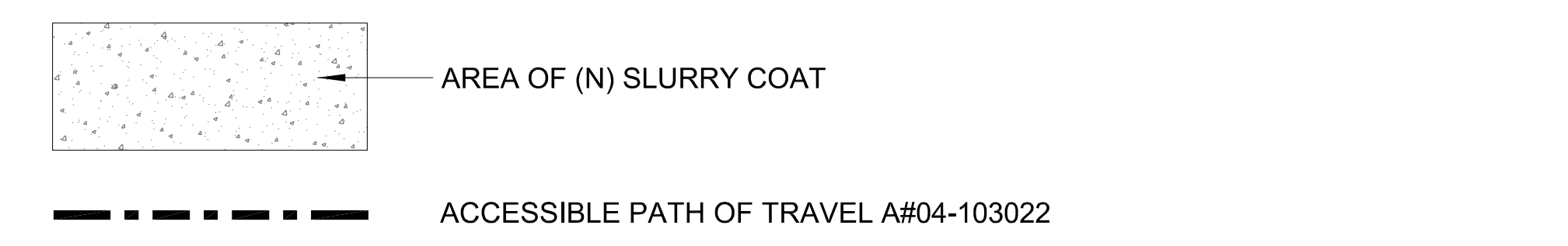

KEYNOTES

KEYNOTE	DESCRIPTION
0201	4" WIDE WHITE PAVEMENT STRIPING
0202	4" WIDE BLUE BORDER PAVEMENT STRIPING
0203	PAINTED ACCESSIBLE SYMBOL, REF DETAIL 1/A2.1
0204	12" TALL PAINTED WHITE TEXT
0205	ACCESSIBLE PARKING SIGN, CONFORM TO DETAIL 2/A2.1
0206	VAN ACCESSIBLE PARKING SIGN, CONFORM TO DETAIL 3/A2.1
0207	12" WIDE WHITE PAVEMENT STRIPING
0209	STANDARD PARKING STALL PAVEMENT STRIPING, REF DETAIL 8/A2.1
0210	4" WIDE WHITE DIAGONAL PAVEMENT STRIPING
0212	4" WIDE BLUE PAVEMENT STRIPING
0213	4" WIDE YELLOW PAVEMENT STRIPING
0214	TOW-AWAY SIGN, CONFORM TO DETAIL 4/A2.1
0215	CONC CURB RAMP, CONFORM TO DETAIL 13/A2.1
0216	CONC CURB CUT, CONFORM TO DETAIL 17/A2.1
0217	ACCESSIBLE CROSSWALK, 5% MAX SLOPE IN DIRECTION OF PATH, 2% MAX CROSS SLOPE, 4" WIDE WHITE PAVEMENT BORDER AND DIAGONAL STRIPING
0220	(E) WHEEL STOP
0222	PROVIDE FLUSH TRANSITION
0270	TRAFFIC ARROW PAVEMENT STRIPING, REF DETAIL 15/A2.1
0271	TRUNCATED DOMES, CONFORM TO DETAIL 14/A2.1

NOTE:
 1. REFER TO DETAIL 9, 10/A2.1 FOR ADDITIONAL INFO.

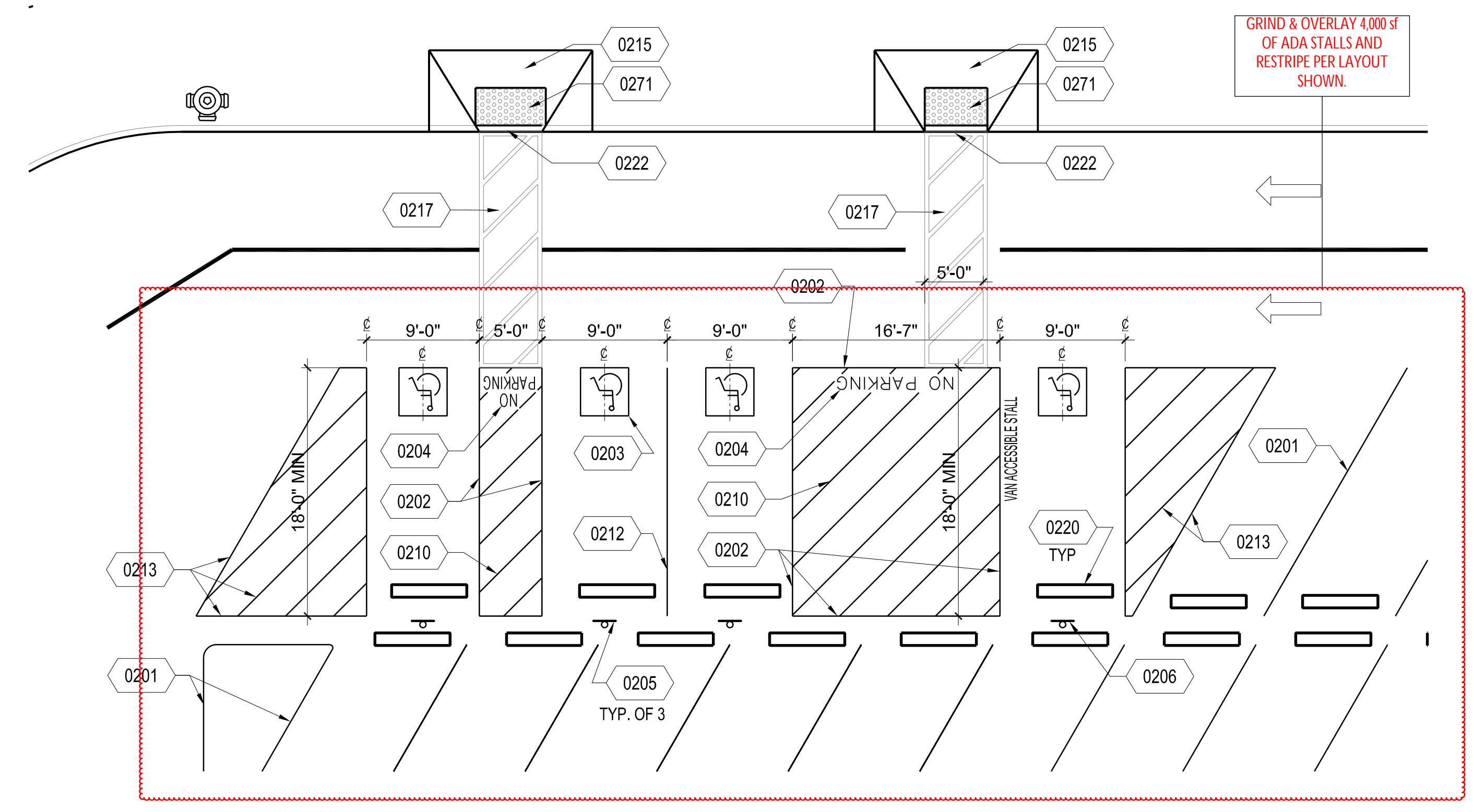

ACCESSIBLE PARKING STALLS 1/8" = 1'-0" 2

NOTE:
 1. REFER TO DETAIL 11/A2.1 FOR ADDITIONAL INFO.

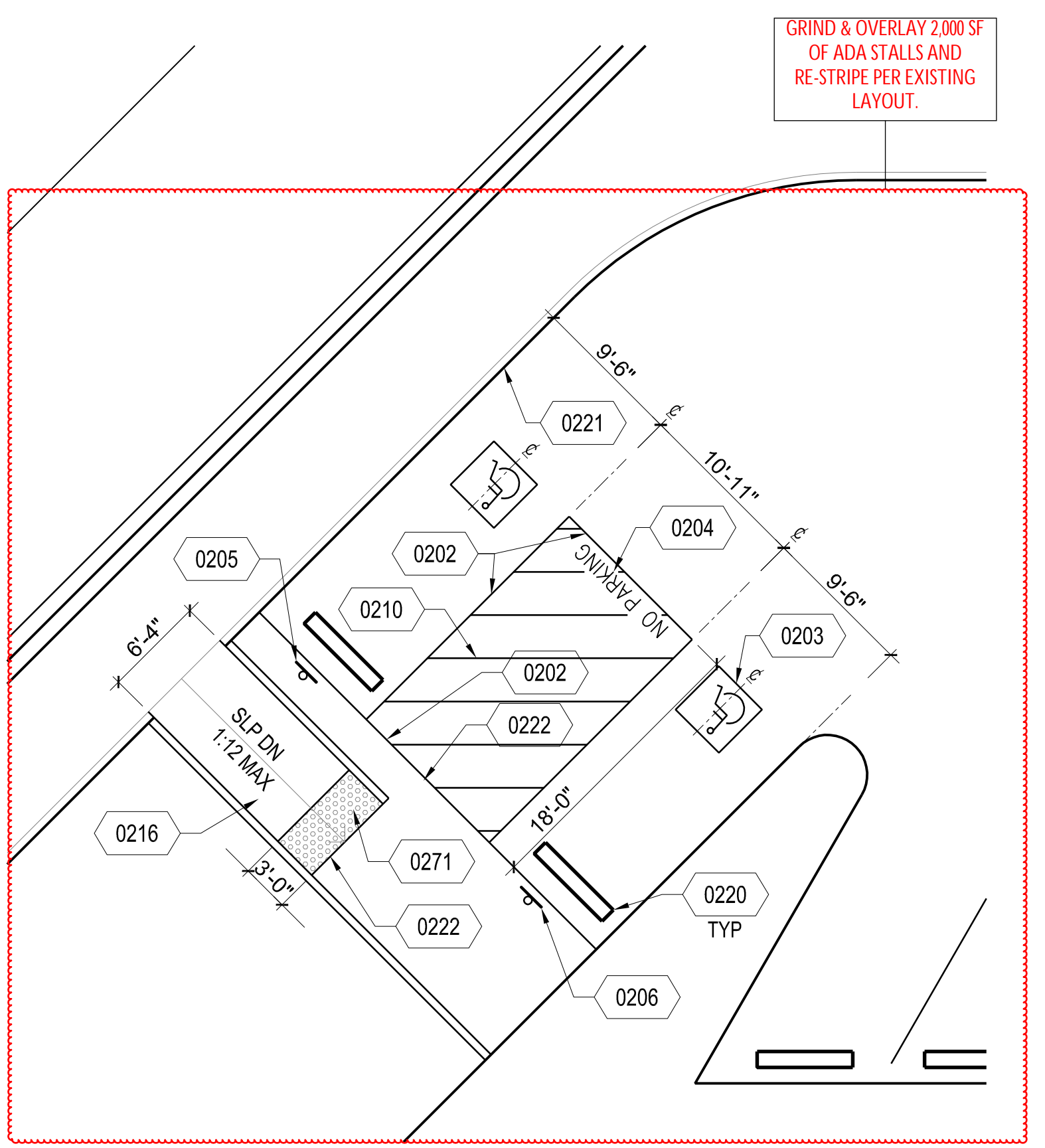

ACCESSIBLE PARKING STALLS 1/8" = 1'-0" 3

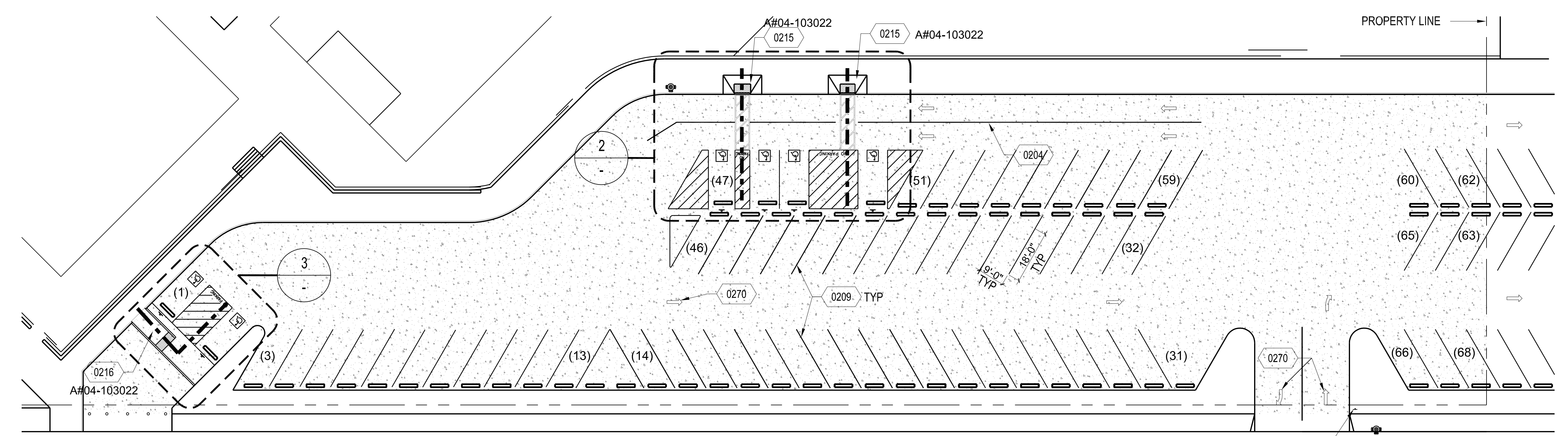

ENLARGED SITE PLAN - AREA 1 1" = 20'-0" 1

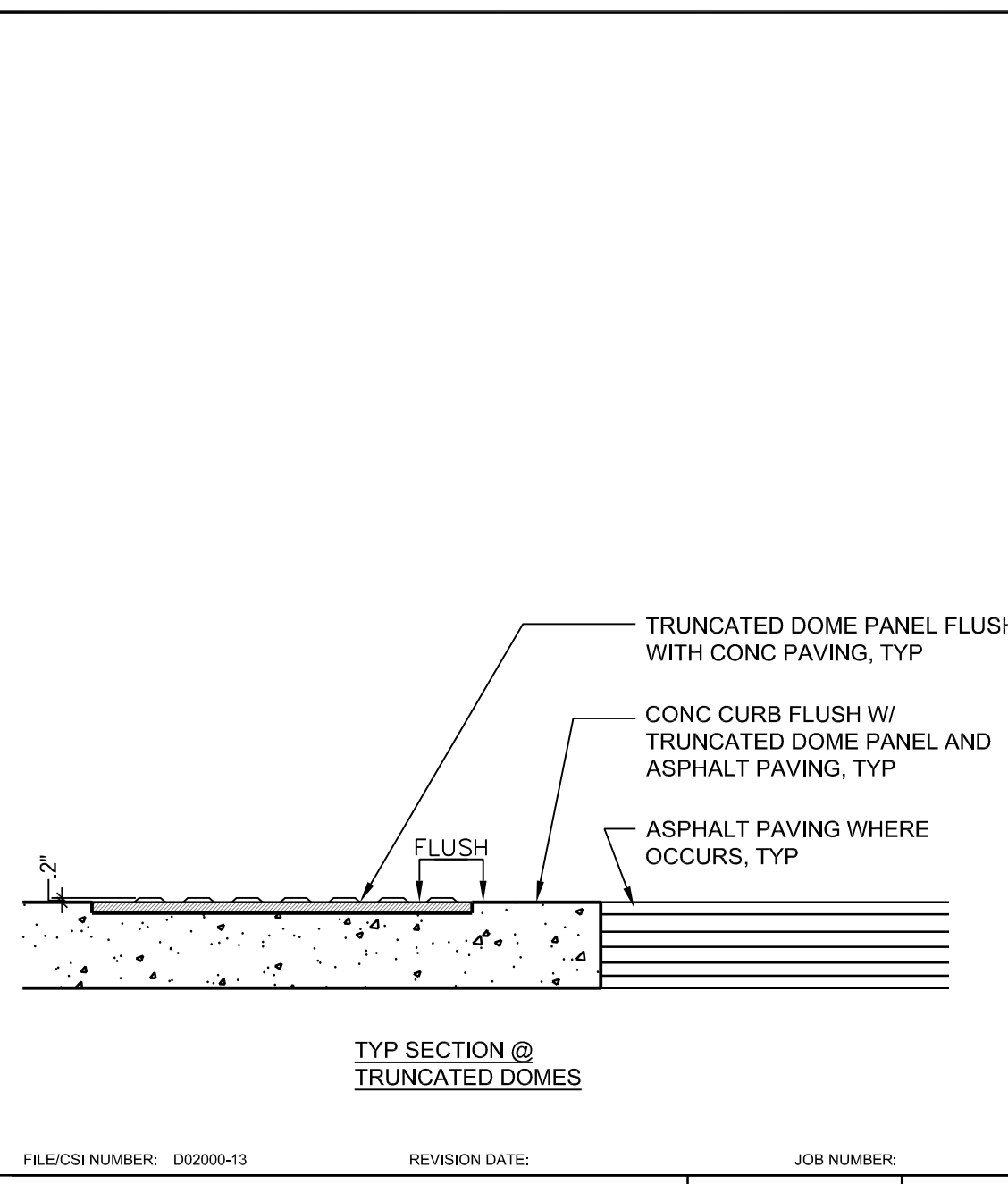

TRUNCATED DOME SECTION 1-1/2"=1'-0" 17

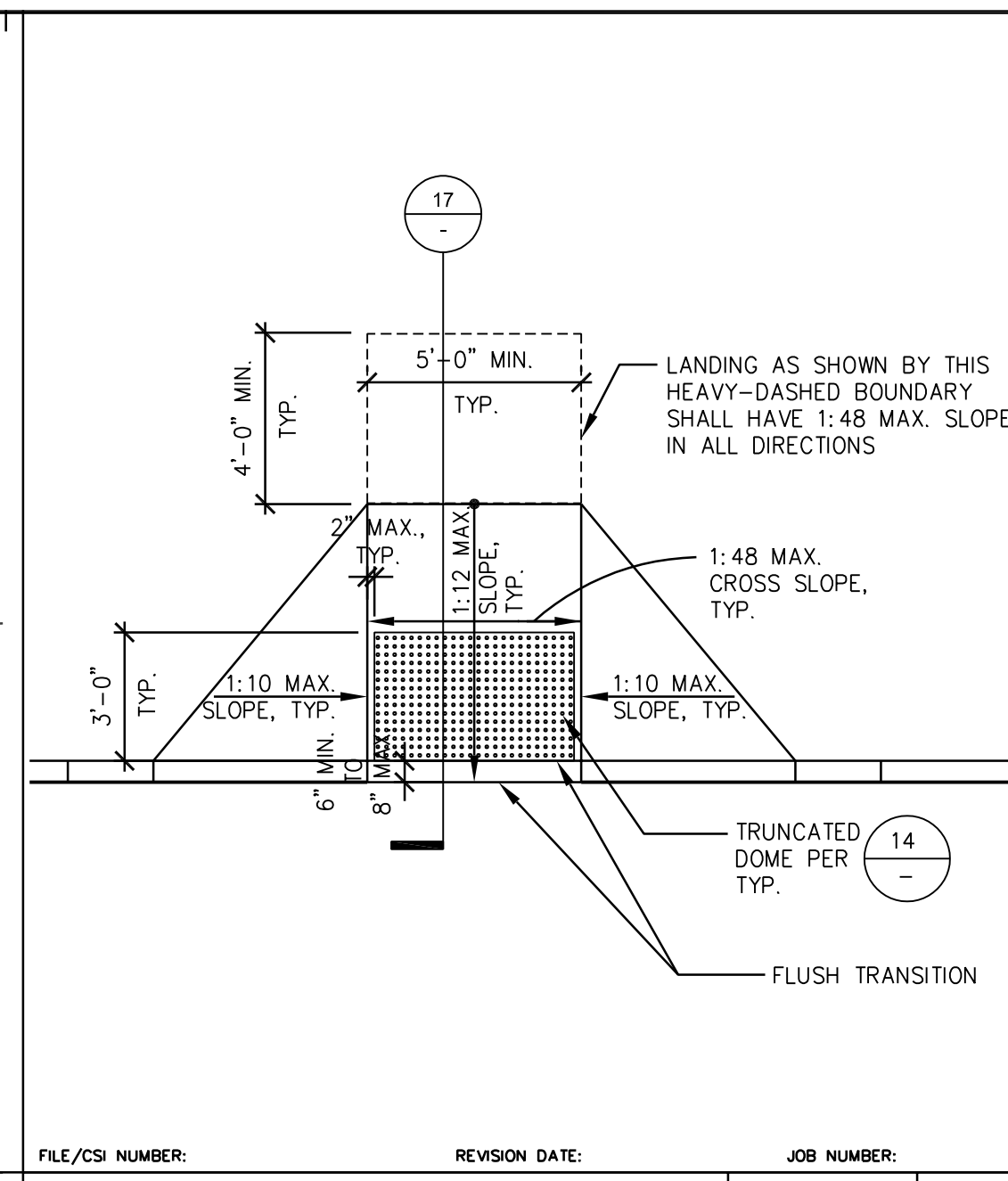

CURB RAMP DETAIL 1/4"=1'-0" 13

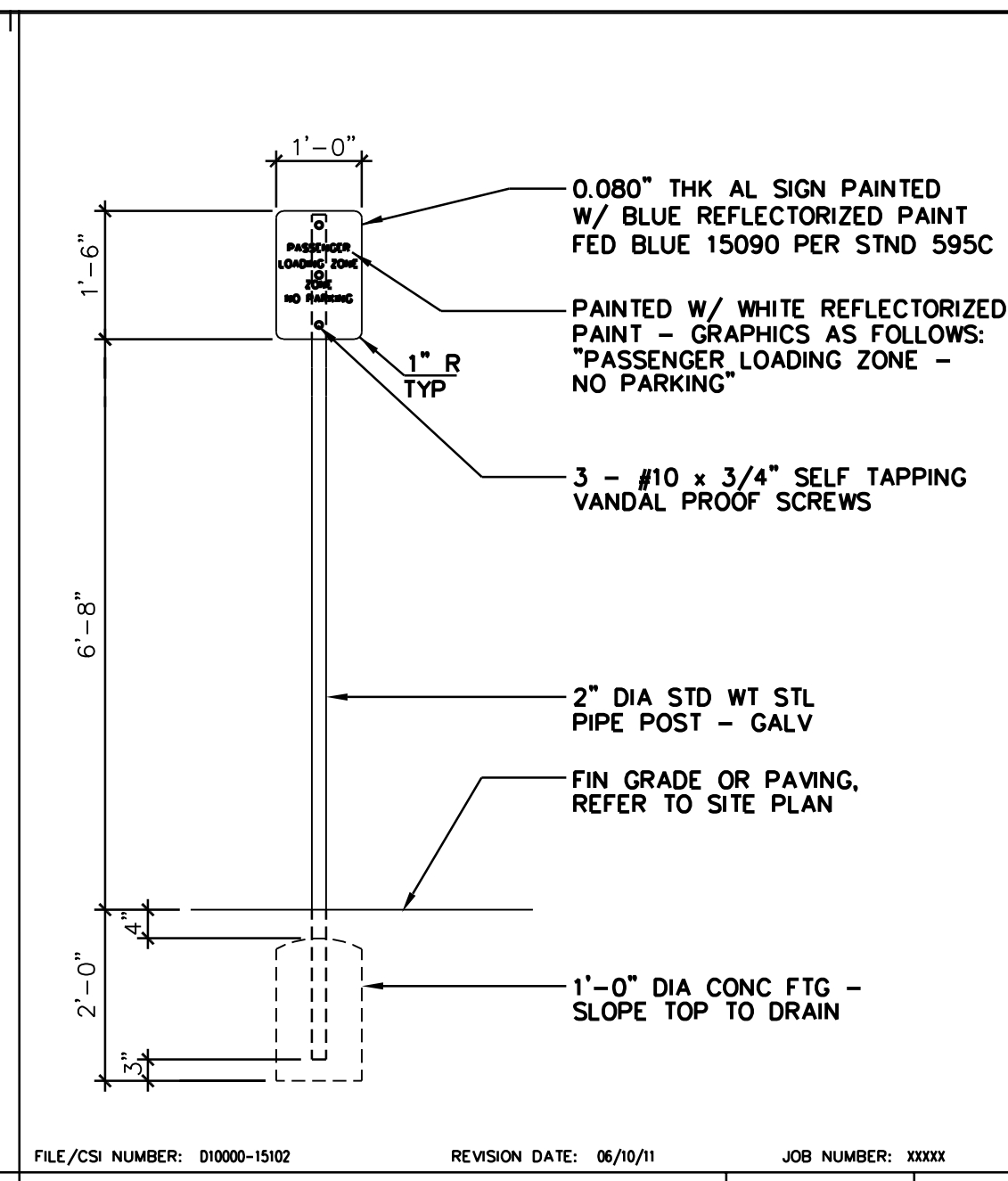

DROP-OFF SIGN 1/2"=1'-0" 5

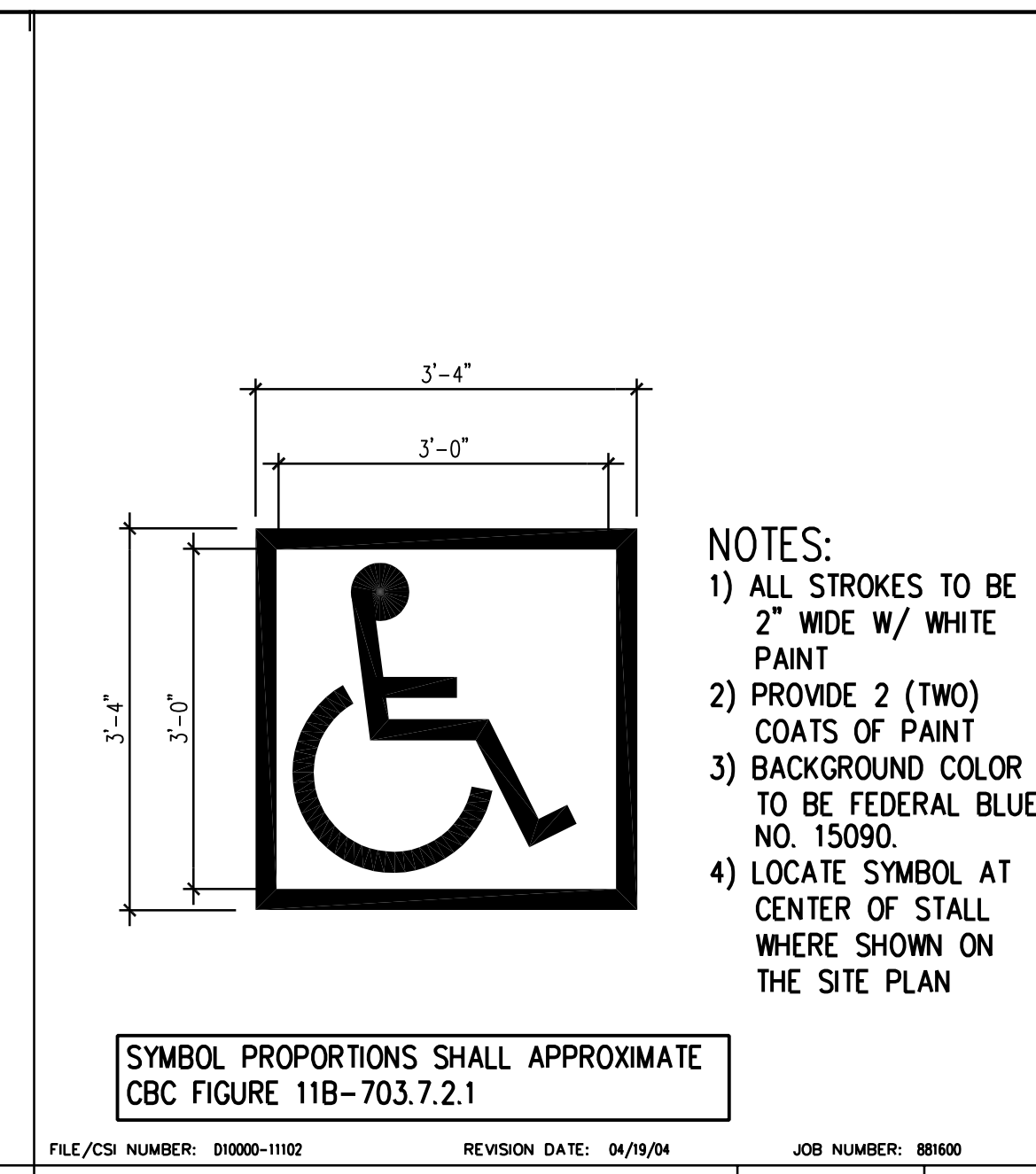

ISA PAVEMENT SYMBOL 3/4"=1'-0" 1

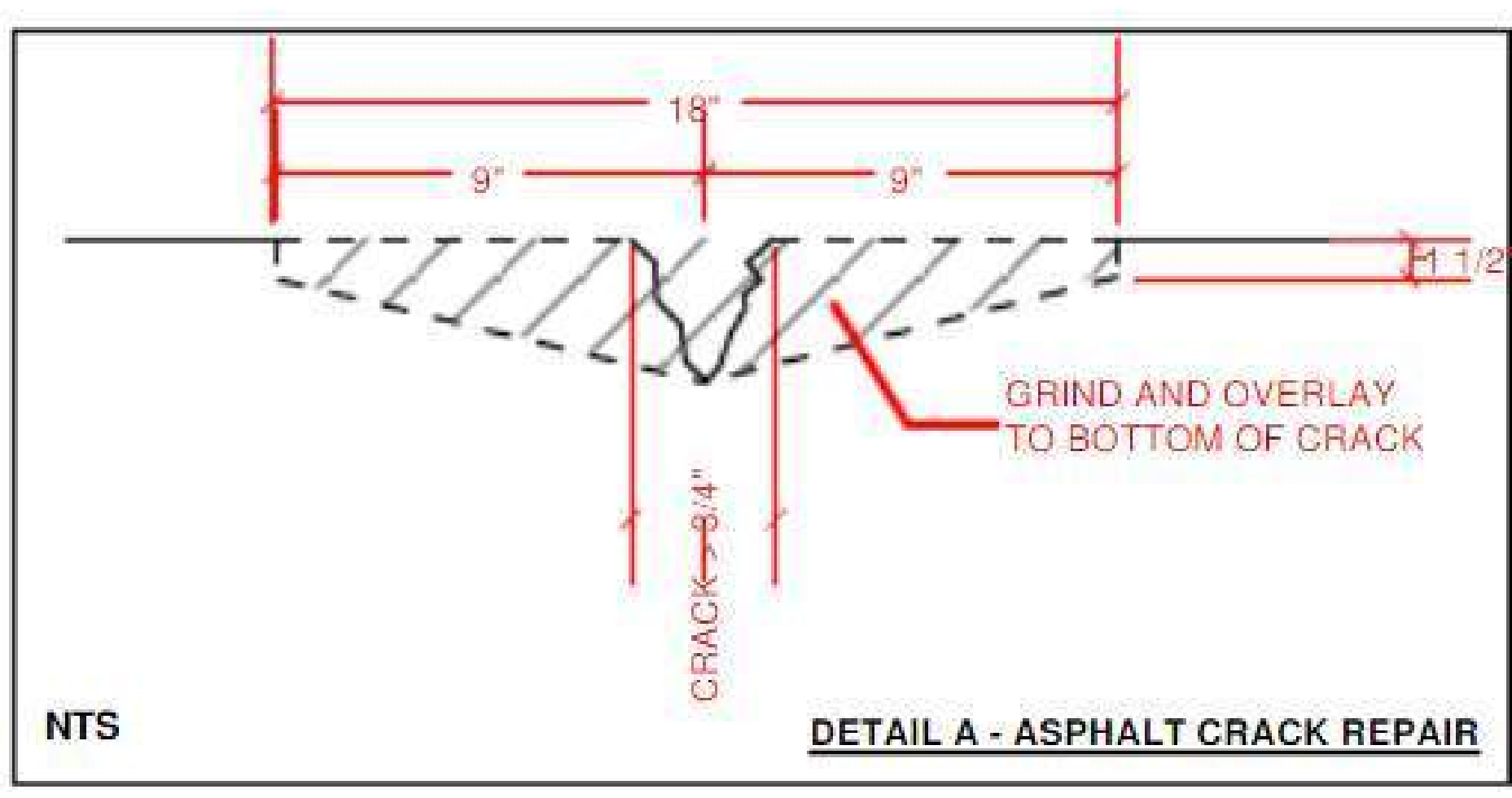

DETAIL A - ASPHALT CRACK REPAIR

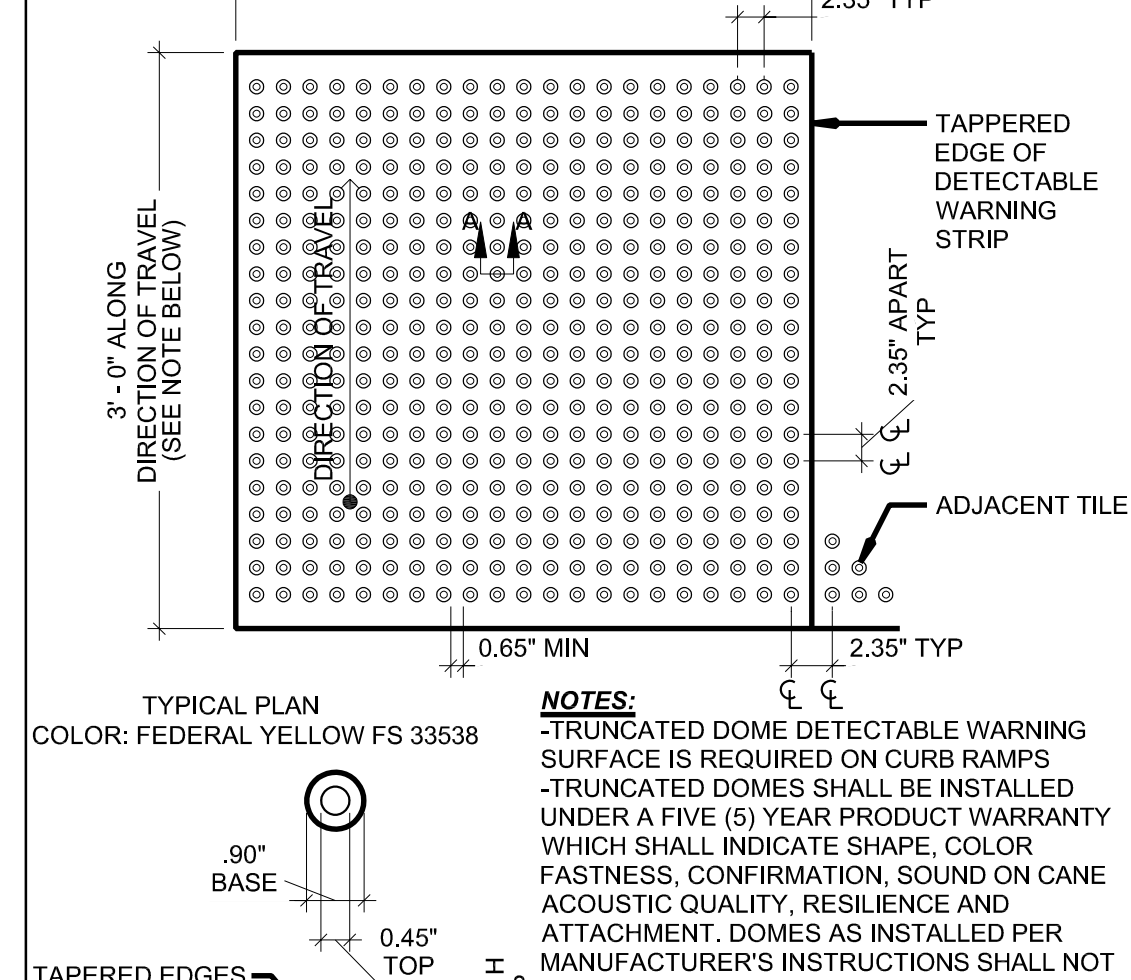

TRUNCATED DOMES DETAILS 1"=1'-0" 14

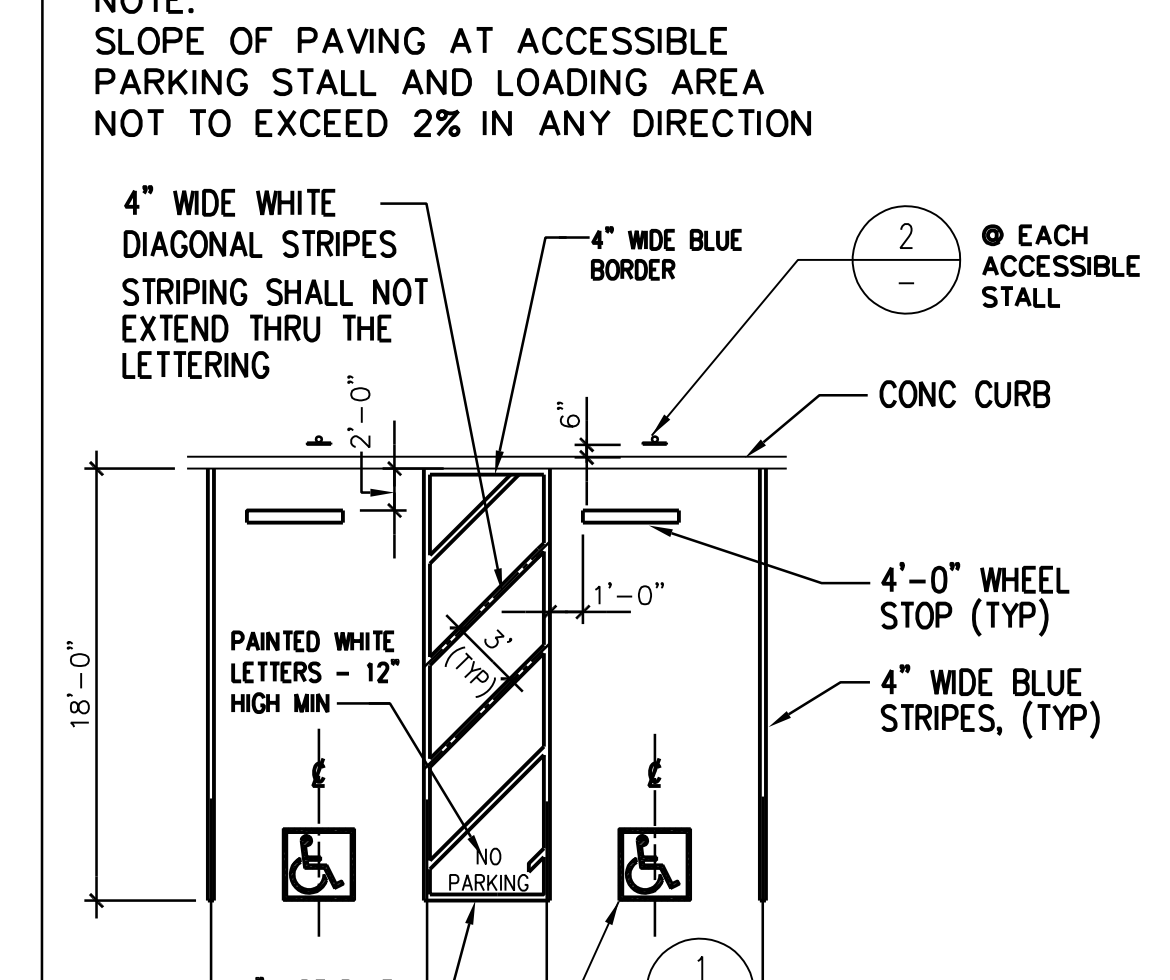

ACCESSIBLE STALL STRIPING DETAIL 1/8"=1'-0" 10

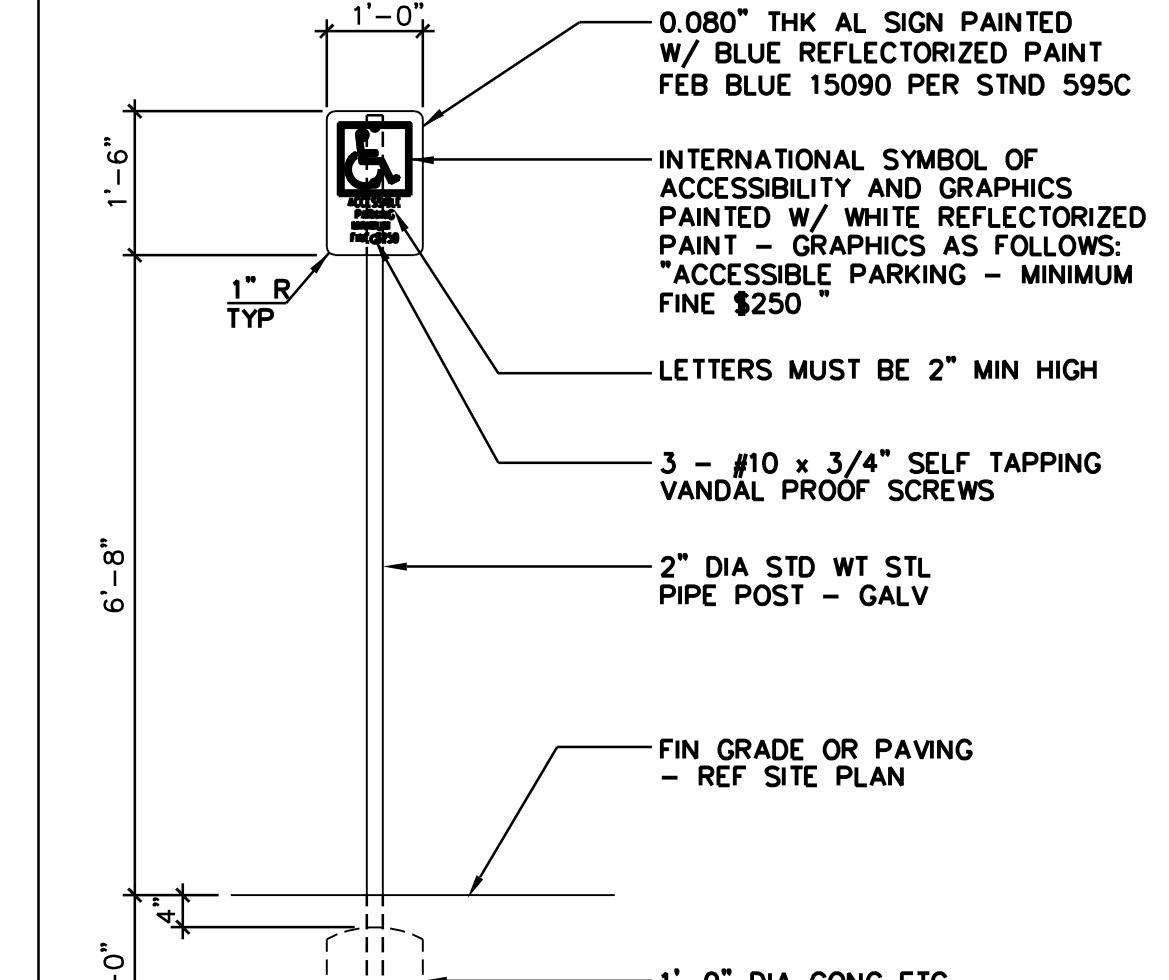

PARKING SIGN 1/2"=1'-0" 2

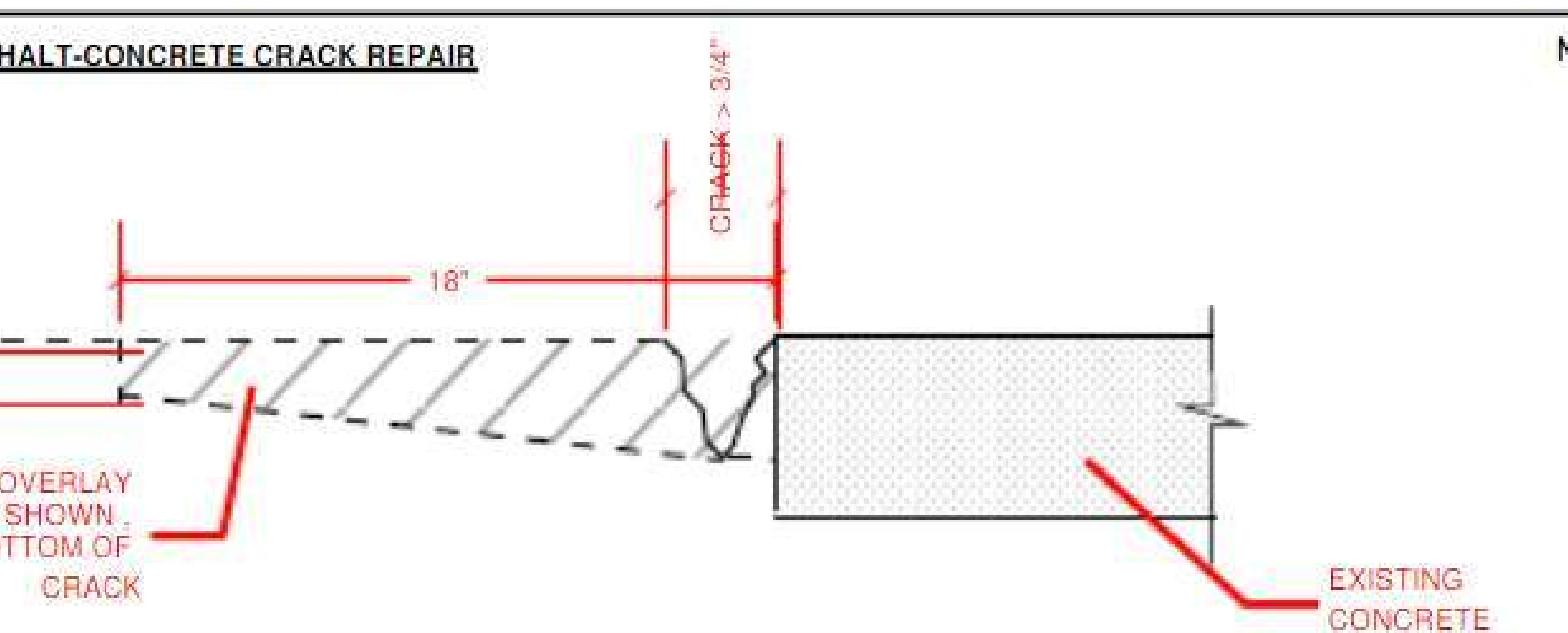

DETAIL B - ASPHALT-CONCRETE CRACK REPAIR

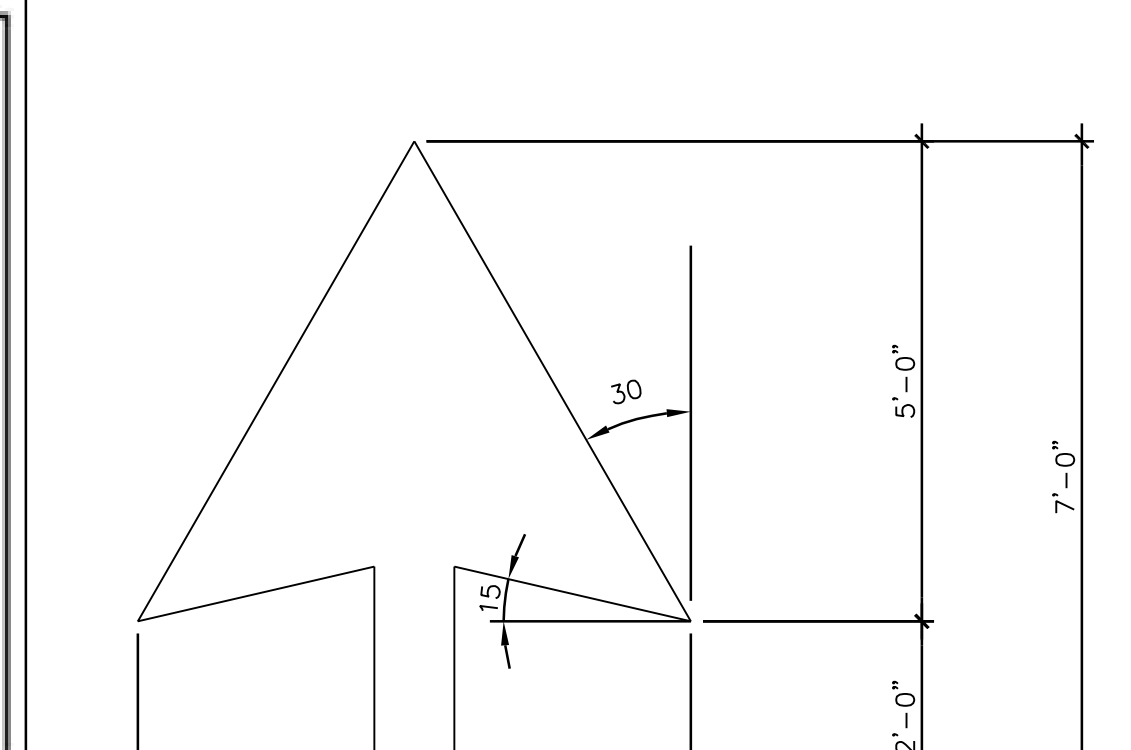

TRAFFIC ARROW 1/2"=1'-0" 15

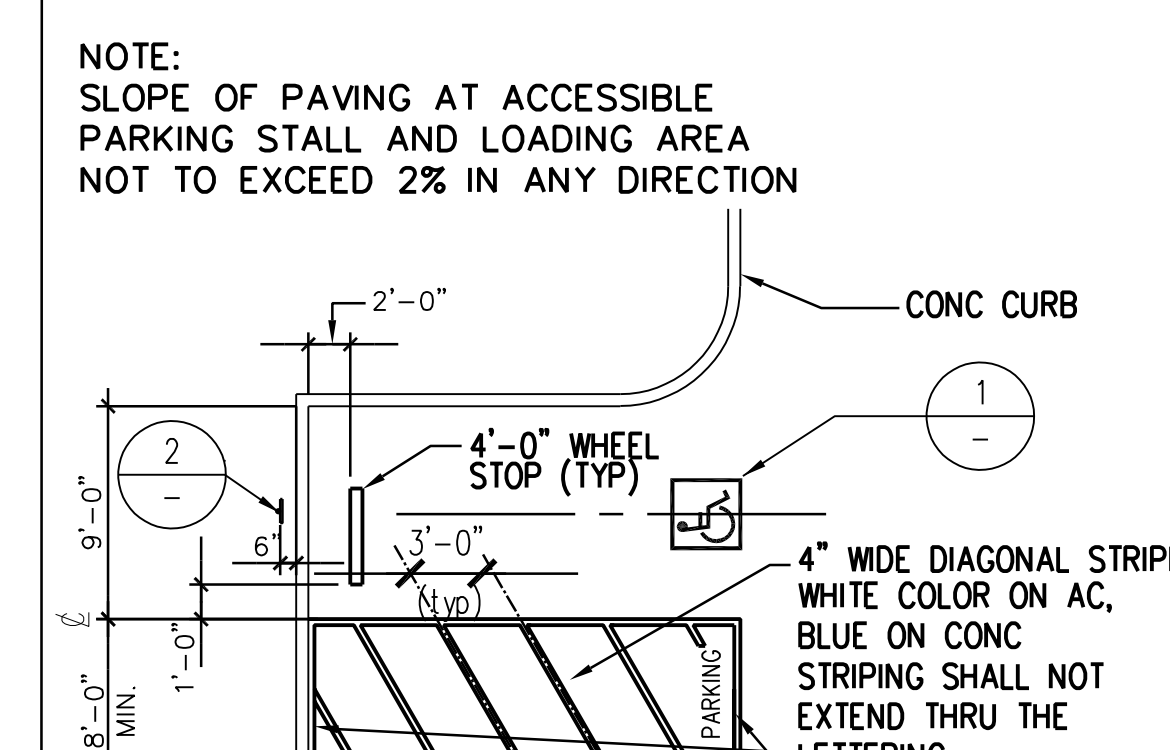

PERPENDICULAR PARKING 1/8"=1'-0" 11

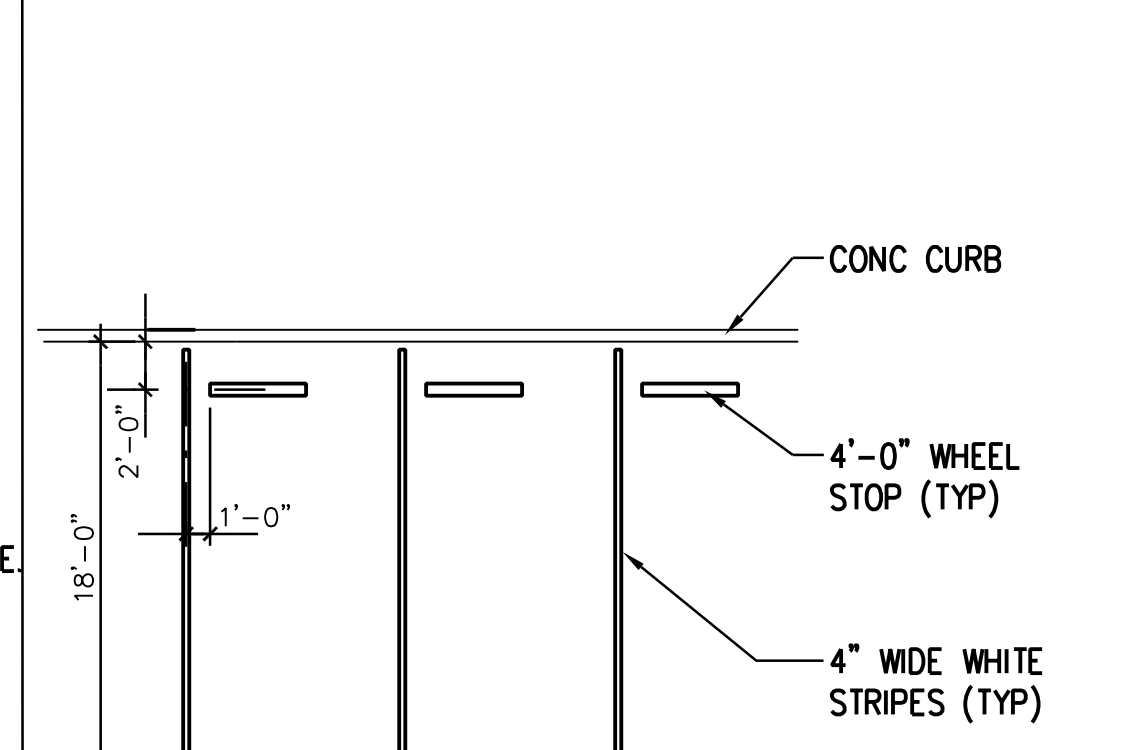

STANDARD STALL STRIPING DETAIL 1/8"=1'-0" 7

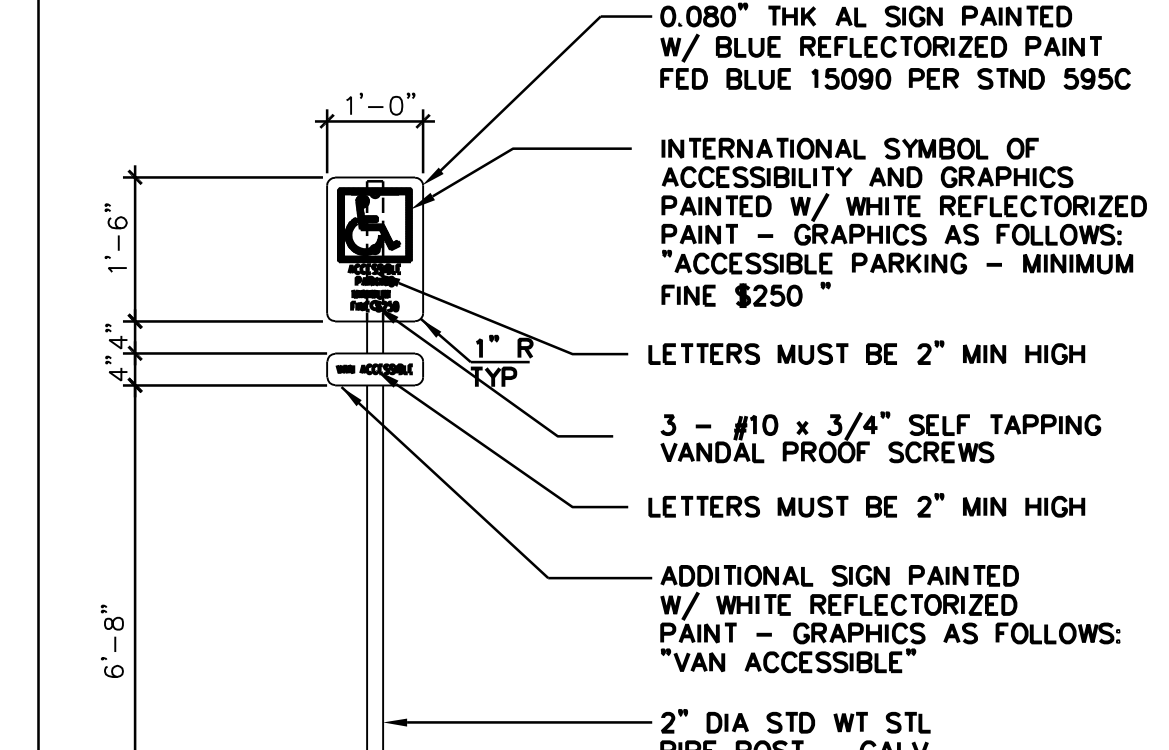

VAN ACCESS. PARKING SIGN 1/2"=1'-0" 3

CONCRETE PAVING:
 1. CEMENT: I ASTM C150, TYPE I OR II
 2. MAXIMUM 1" AGGREGATE
 3. MINIMUM STRENGTH: 2,500 PSI, SLUMP 4 TO 6 INCH
 4. MEDIUM BROOM FINISH
 5. PLACE CONCRETE IN ACCORDANCE WITH ACI 301
 6. PROVIDE TOLERANCE IN ACCORDANCE WITH ACI 117

TRUNCATED DOME, DETECTABLE WARNING PAVEMENT:
 1. SURFACE APPLIED DETECTABLE WARNING SYSTEM SHALL MEET NOMINAL DIMENSIONAL AND COLOR CONTRAST REQUIREMENTS OF CBC, COR, TITLE 24, PART 2, SECTION 11B-705 AND APPROVED BY DSA/AC
 2. DETECTABLE WARNING PAVEMENT SHALL BE CONSTRUCTED USING THE VITRIFIED POLYMER COMPOSITE ARMOR-TILE SYSTEM MANUFACTURED BY ARMOR-TILE
 3. COLOR OF PAVEMENT SHALL BE OF CONTRASTING YELLOW COLOR CONFORMING TO 338538 IN ACCORDANCE WITH FEDERAL STANDARD 595C.
 4. INSTALL DETECTABLE WARNING PAVEMENT IN ACCORDANCE WITH MANUFACTURER'S REQUIREMENT AND THE 2010 ADA STANDARDS FOR ACCESSIBLE DESIGN AND CBC TITLE 24, PART 2, SECTION 11B-705 REQUIREMENTS.

SPECIFICATION NTS 20

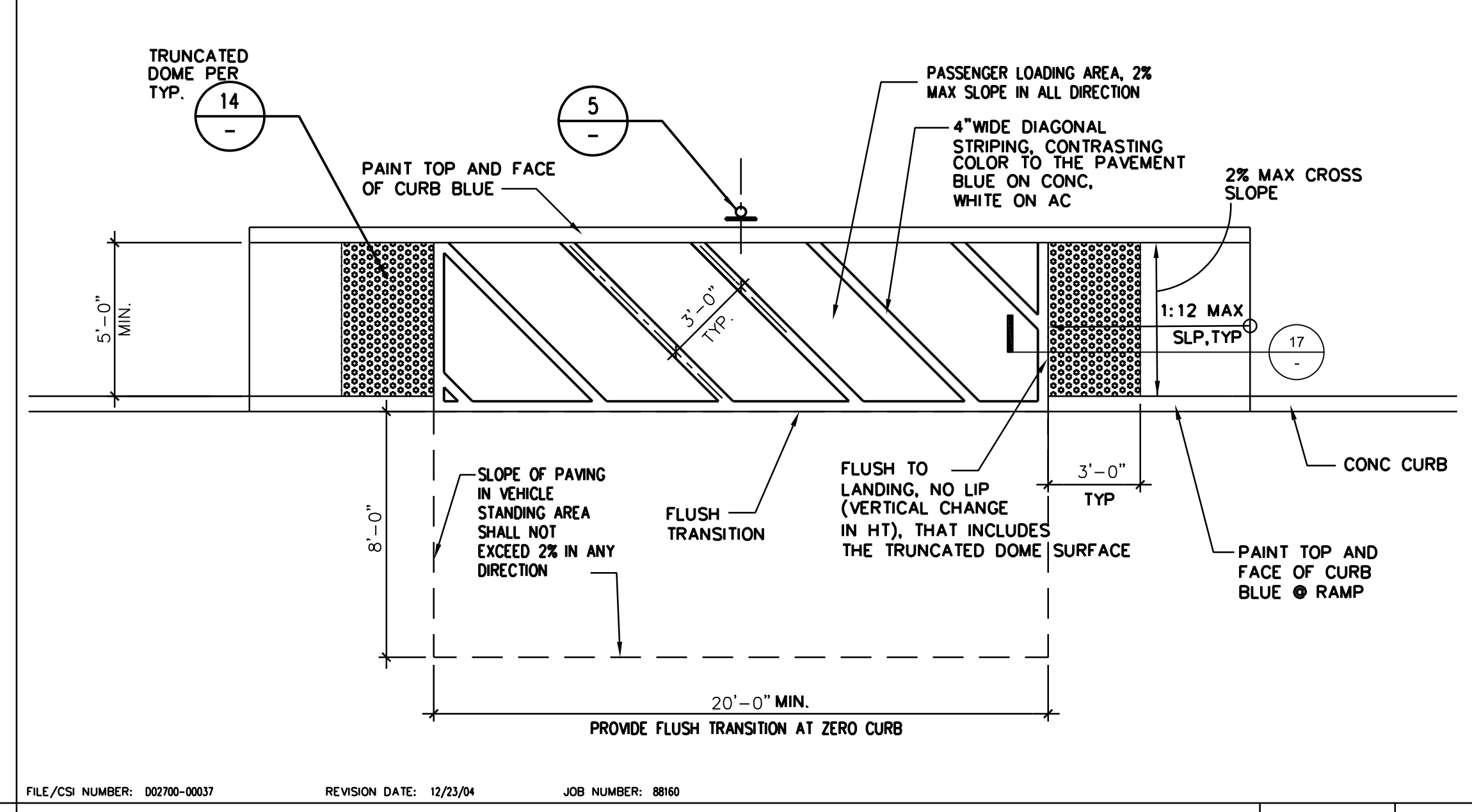

PASSENGER LOADING ZONE 1/4"=1'-0" 12

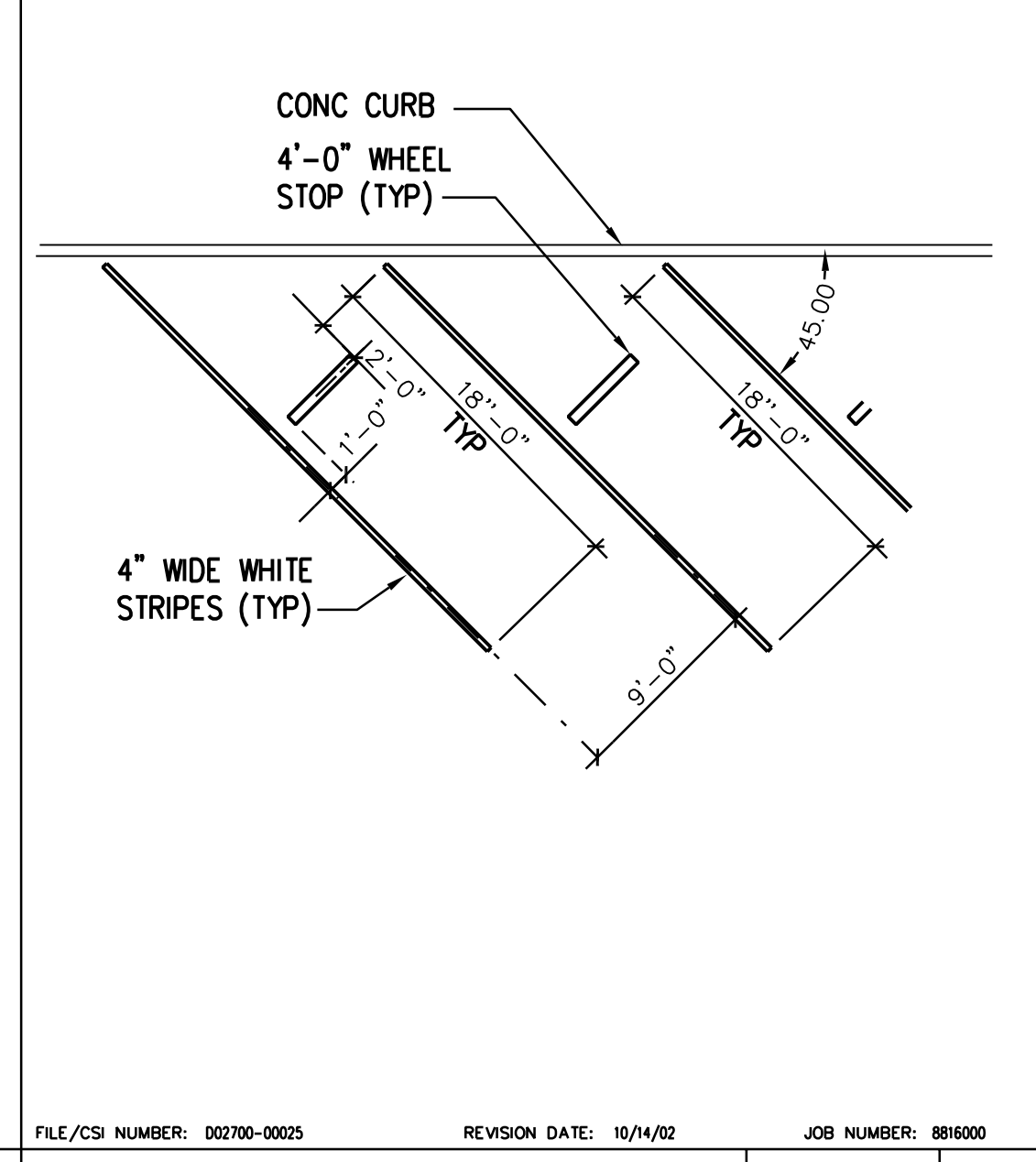

STANDARD STALL STRIPING DETAIL 1/8"=1'-0" 8

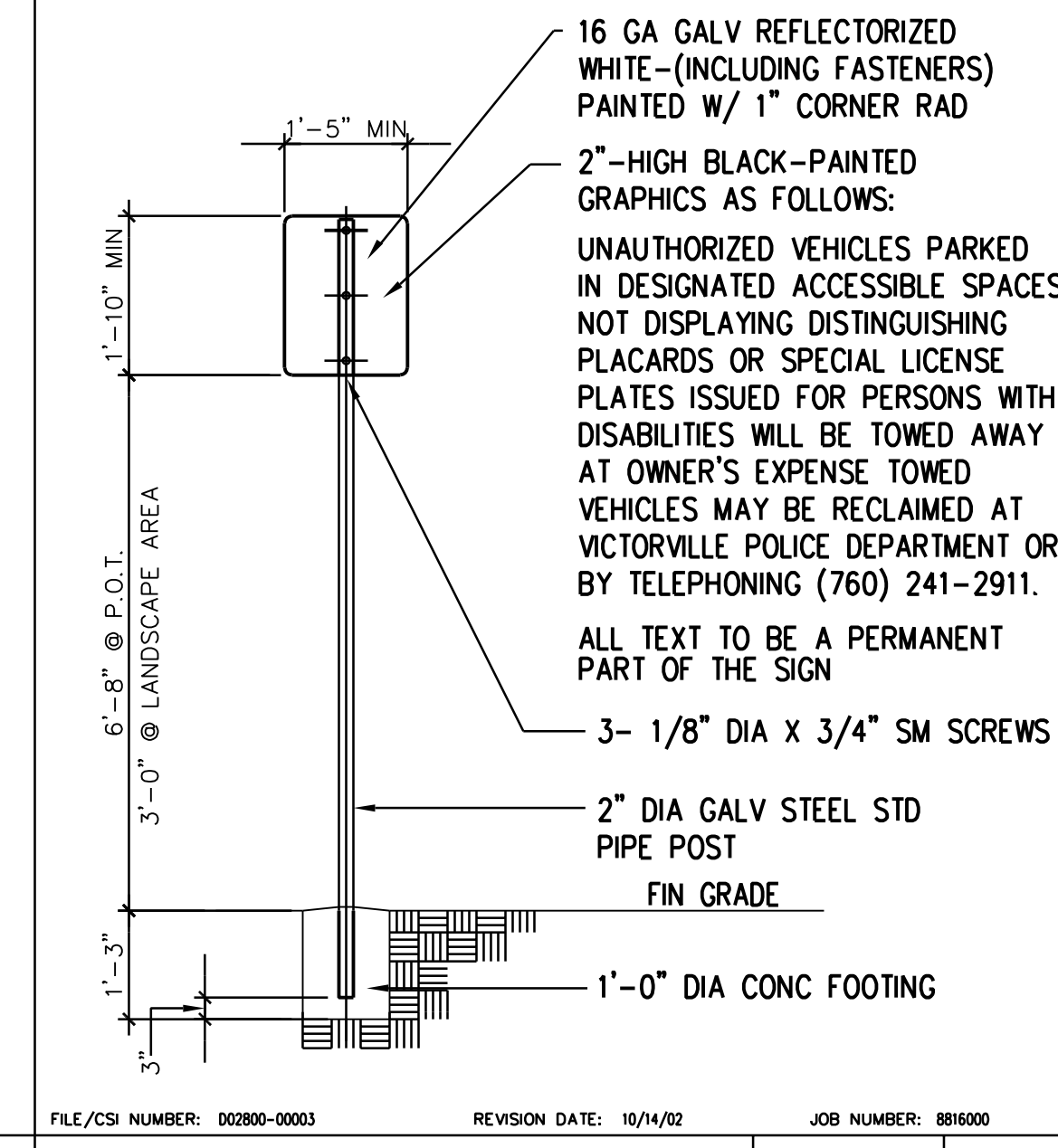

UNAUTHORIZED PARKING SIGNAGE 1/2"=1'-0" 4

: REMOVE & REPLACE

: GRIND & OVERLAY

Permanent Buildings
 Relocatable Buildings

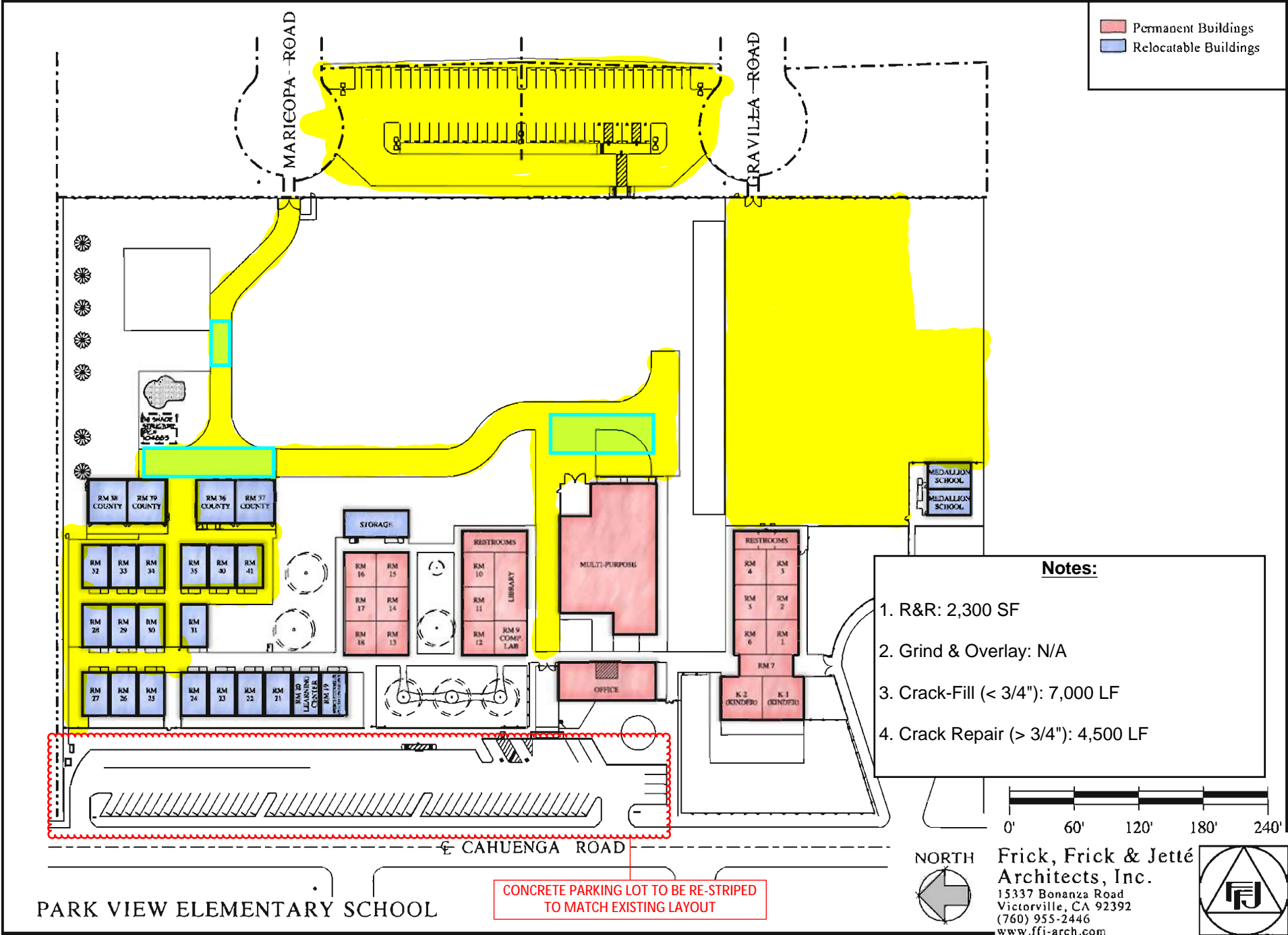

- Notes:**
- 1. R&R: 2,300 SF
 - 2. Grind & Overlay: N/A
 - 3. Crack-Fill (< 3/4"): 7,000 LF
 - 4. Crack Repair (> 3/4"): 4,500 LF



PARK VIEW ELEMENTARY SCHOOL

CONCRETE PARKING LOT TO BE RE-STRIPED TO MATCH EXISTING LAYOUT



Frick, Frick & Jetté Architects, Inc.
15337 Bonanza Road
Victorville, CA 92392
(760) 955-2446
www.ffj-arch.com



: REMOVE & REPLACE

: GRIND & OVERLAY

Permanent Buildings
 Relocatable Buildings

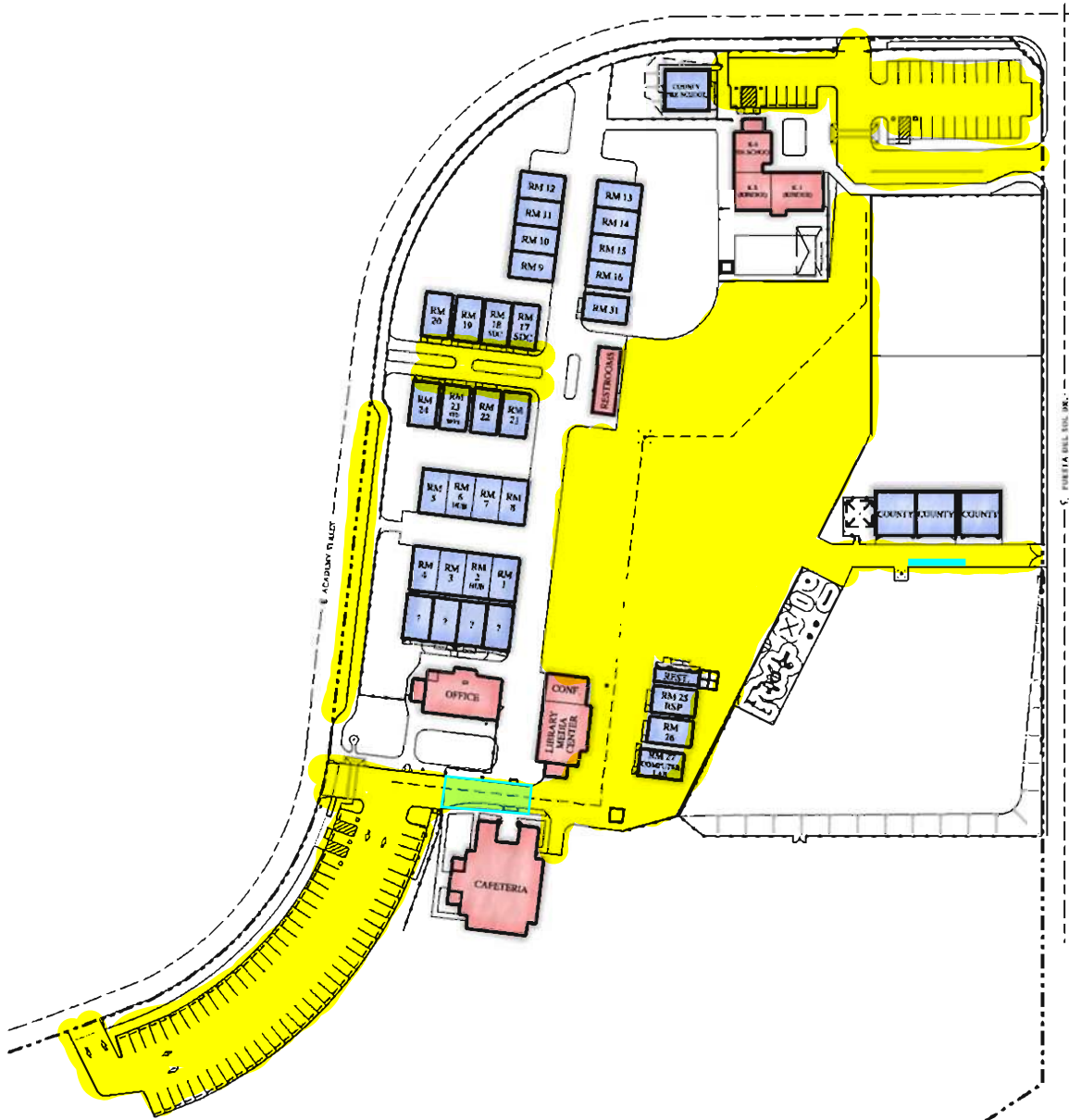

Notes:

1. R&R: 1,400 SF
2. Grind & Overlay: N/A
3. Crack-Fill (< 3/4"): 1,500 LF
4. Crack Repair (> 3/4"): 1,500 LF

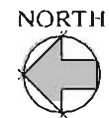
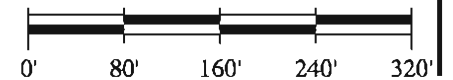

Frick, Frick & Jetté
Architects, Inc.
15337 Bonanza Road
Victorville, CA 92392
(760) 955-2446
www.ffj-arch.com



PUESTA DEL SOL ELEMENTARY SCHOOL

: REMOVE & REPLACE

: GRIND & OVERLAY

Permanent Buildings
 Relocatable Buildings

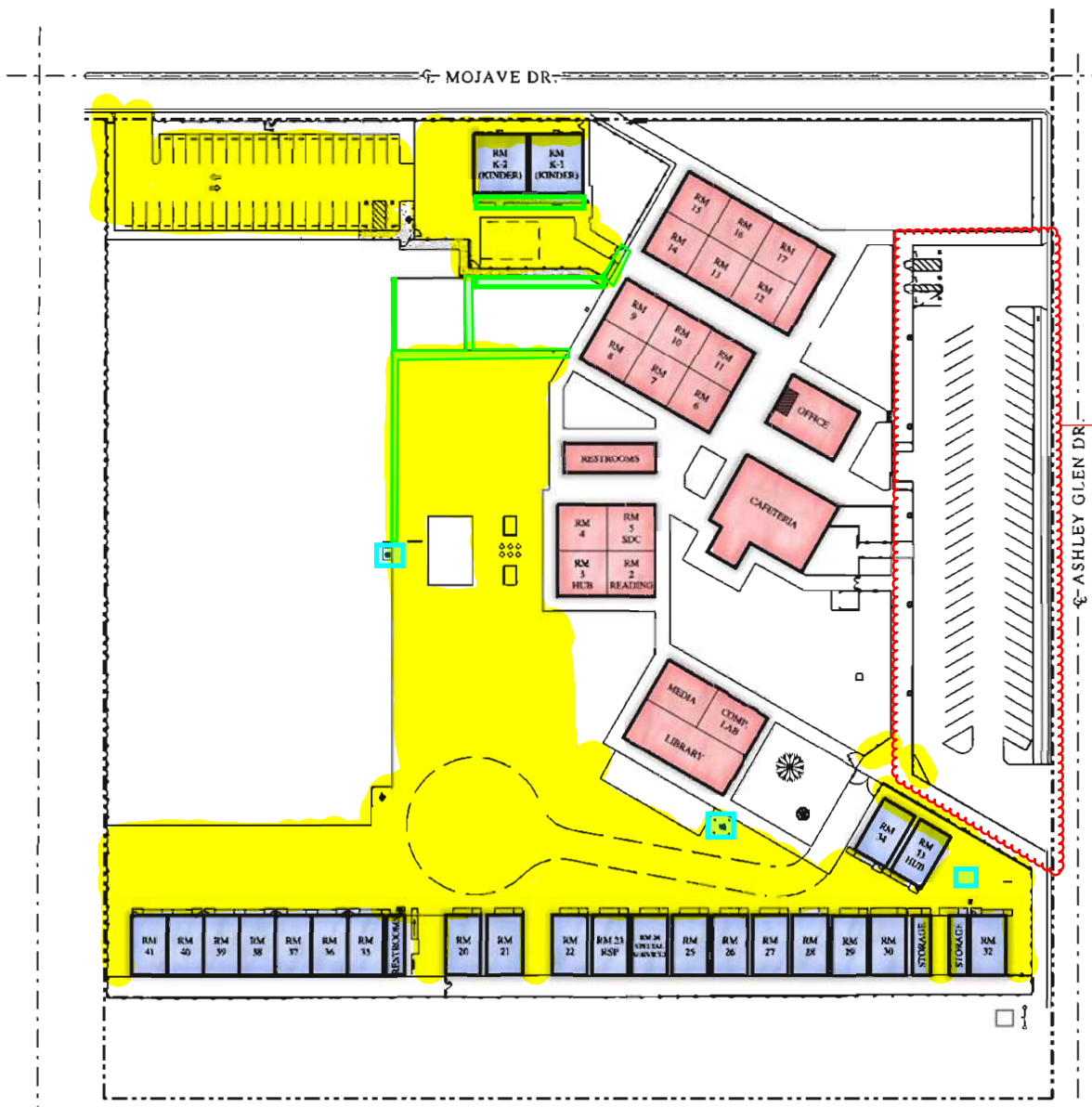

CONCRETE PARKING LOT TO BE RE-STRIPED TO MATCH EXISTING

Notes:

1. R&R: 100 SF
2. Grind & Overlay: 200 SF
3. Crack-Fill (< 3/4"): 1,500 LF
4. Crack Repair (> 3/4"): 1,500 LF

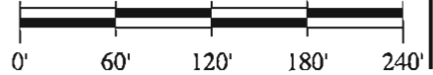

Frick, Frick & Jetté Architects, Inc.
 15337 Bonanza Road
 Victorville, CA 92392
 (760) 955-2446
 www.ffj-arch.com



VILLAGE ELEMENTARY SCHOOL

: REMOVE & REPLACE

: GRIND & OVERLAY

Permanent Buildings
 Relocatable Buildings

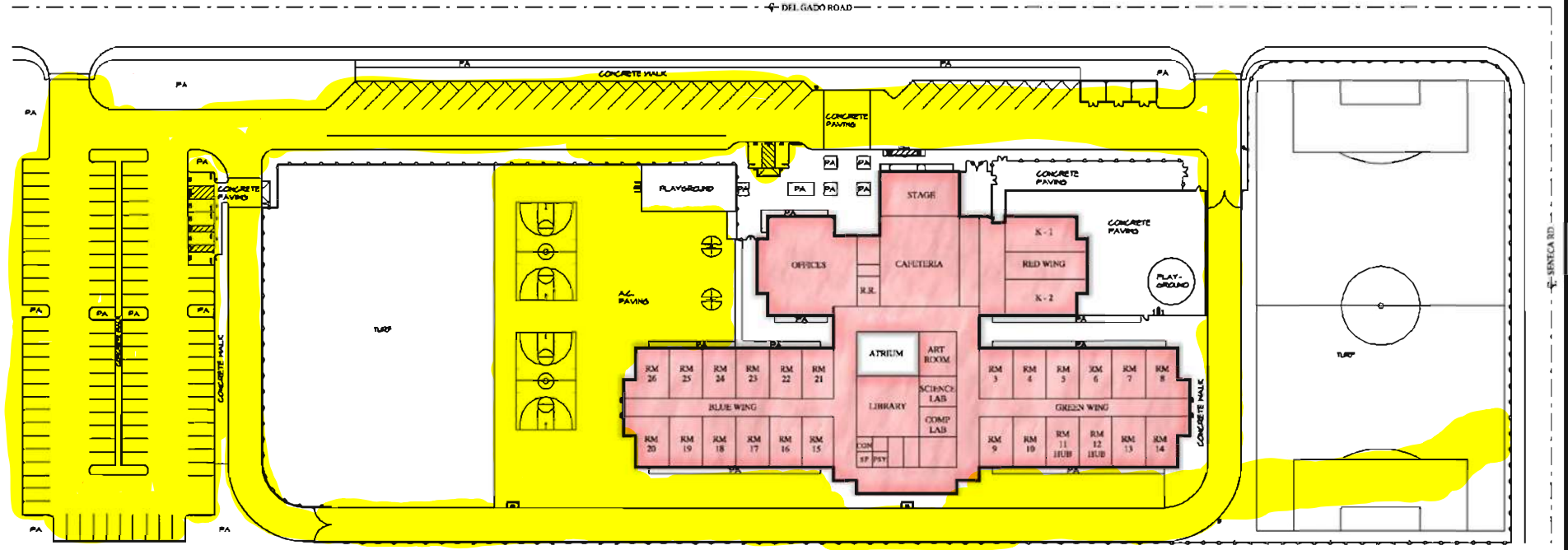

- Notes:**
1. R&R: N/A
 2. Grind & Overlay: N/A
 3. Crack-Fill (< 3/4"): 350 LF
 4. Crack Repair (> 3/4"): 3,000 LF

WEST PALMS CONSERVATORY

Total Capacity: 725

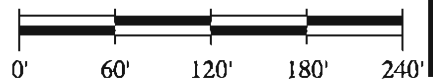

Frick, Frick & Jetté Architects, Inc.
15337 Bonanza Road
Victorville, CA 92392
(760) 955-2446
www.ffj-arch.com





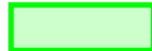

: REMOVE & REPLACE



: GRIND & OVERLAY

 Permanent Buildings
 Relocatable Buildings

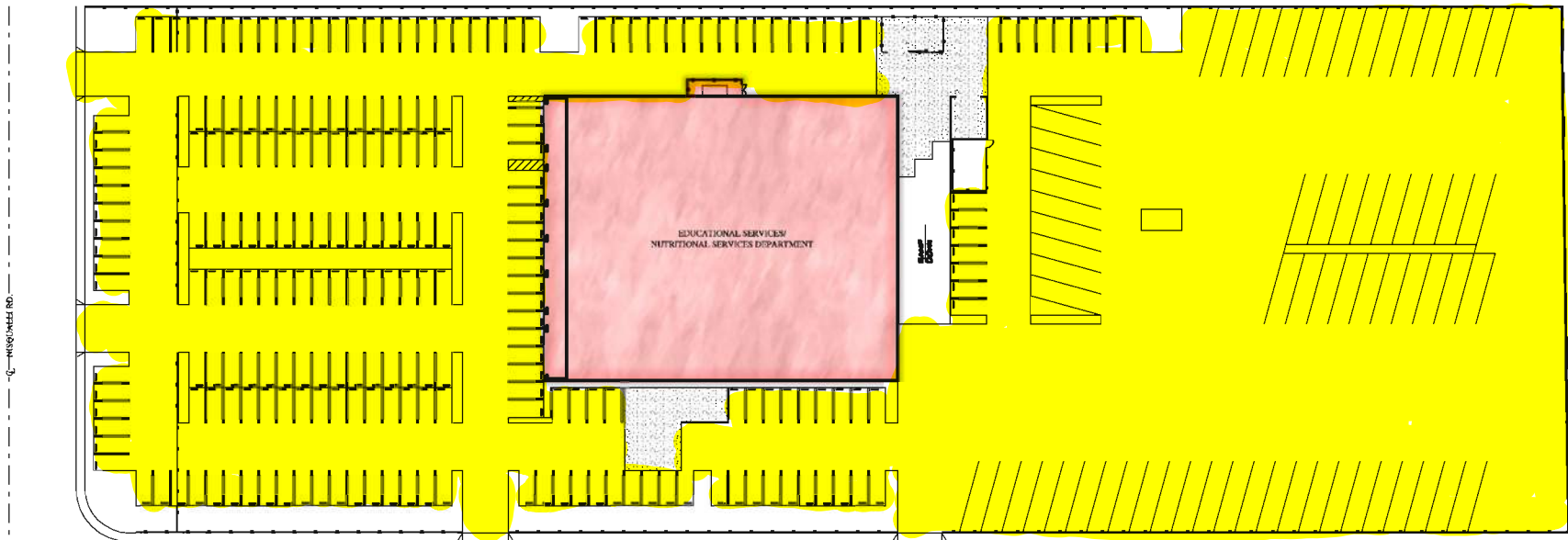

Notes:

1. R&R: N/A
2. Grind & Overlay: N/A
3. Crack-Fill (< 3/4"): 1,000 LF
4. Crack Repair (> 3/4"): 1,000 LF

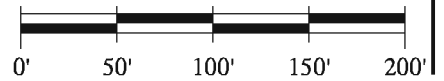

Frick, Frick & Jetté
Architects, Inc.
 15337 Bonanza Road
 Victorville, CA 92392
 (760) 955-2446
www.ffj-arch.com



EDUCATIONAL SERVICES/NUTRITIONAL SERVICES DEPARTMENT

CRACK REPAIR > 3/4" DETAIL SHEET

